

XR1464

Constant Coverage Horn

Key Features

- 1.4 inch throat entry
- Aluminium construction for excellent heat transfer
- Uniform on-axis and off-axis frequency response
- 60° x 40° horizontal and vertical constant coverage
- Very low distortion at high sound pressure
- Improved compression driver cooling
- Rotatable structure



General Description

The XR1464 is a 1.4 inch throat entry constant directivity horn. The horn has been developed to reach optimum performances when it will be coupled with 1.4 inch exit Eighteen Sound high frequency compression drivers.

All XR series horns have been designed in order to reach smooth driver frequency response, to maintain constant coverage and directivity and eliminating the midrange narrowing and high frequency beaming problems common of many similar horns on the market.

XR series horns are made in low pressure injected aluminium material in order to obtain the best performance under many points of view:

- thermal: aluminum horns are capable to reduce up to 30°C the steady state compression driver working temperature at full power, when compared to equivalent size plastic horn. This gives lower power compression ratio (down to 1dB) and higher driver power handling (30% higher);
- mechanical: aluminum horns do not require any support for the compression driver (like brackets), and at the same time eliminate the problem of horn resonance with optimum waterfall and impulse system behavior.

The XR1464 maintains nominal 60° Horizontal x 40° Vertical pattern control. It provides consistent on-axis and off-axis frequency response from 1,2kHz to 16kHz in both horizontal and vertical planes. Horn directivity is constant down to 1,2kHz.

0421464001

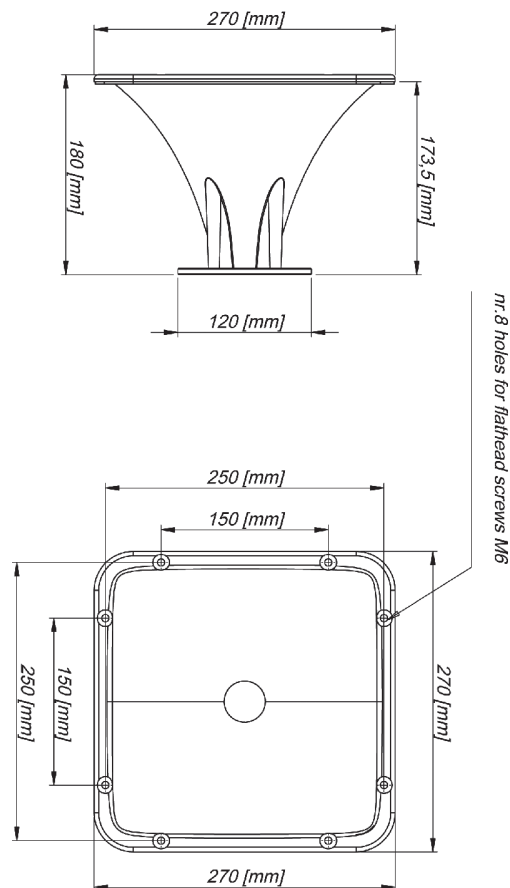

CONSTANT COVERAGE HORNS

XR1464

Constant Coverage Horn

CONSTANT COVERAGE HORNS

GENERAL SPECIFICATIONS

THROAT DIAMETER	35,5 mm (1,4 in)
HORIZONTAL COVERAGE (-6DB)	60° (10 ÷ -2) average range (1,25kHz - 12,5kHz)
VERTICAL COVERAGE (-6 DB)	40° (25 ÷ 0) average range (1,25kHz - 12,5kHz)
DIRECTIVITY INDEX	11 dB (2 ÷ -1) average range (1,25kHz - 12,5kHz)
USABLE FREQUENCY RANGE	Above 800 Hz
RECOMM. CROSS.FREQUENCY	800 Hz or more
SENSITIVITY (ON AXIS) (1)	110 dB
FREQUENCY RANGE	800 Hz ÷ 18KHz
MATERIAL	Low gravity injected aluminum

MOUNTING INFORMATIONS

Mouth Height	270 mm (10,6 in)
Mouth Width	270 mm (10,6 in)
Depth	180 mm (7,1 in)
Mouth Mounting Dimensions	8 ø 6 holes
Net weight	1,9 Kg (4 lb)

HORIZONTAL BEAMWIDTH – RED PLOT – VERTICAL BEAMWIDTH – BLUE PLOT – A

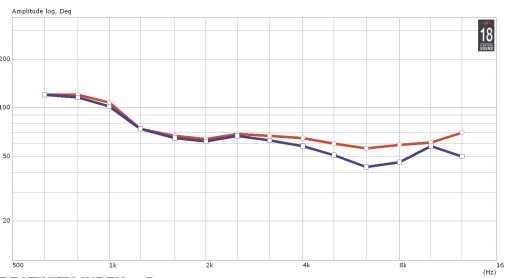

DIRECTIVITY INDEX – B

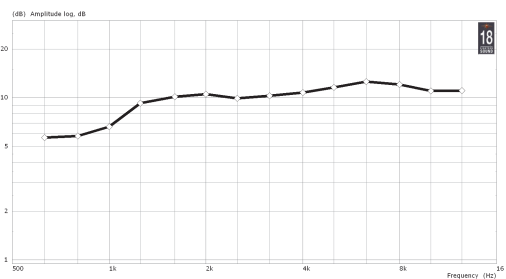

HORIZONTAL POLAR DIRECTIVITY MAP – C
VERTICAL POLAR DIRECTIVITY MAP – D

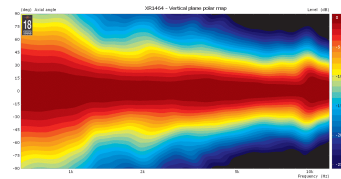
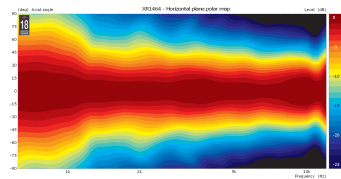

NOTES

(1) Sensitivity is measured at 1W input on ND1480 rated impedance at 1m on axis from the mouth of the horn, averaged between 1kHz and 4 kHz.

HORIZONTAL 1/3 OCTAVE POLAR PLOTS

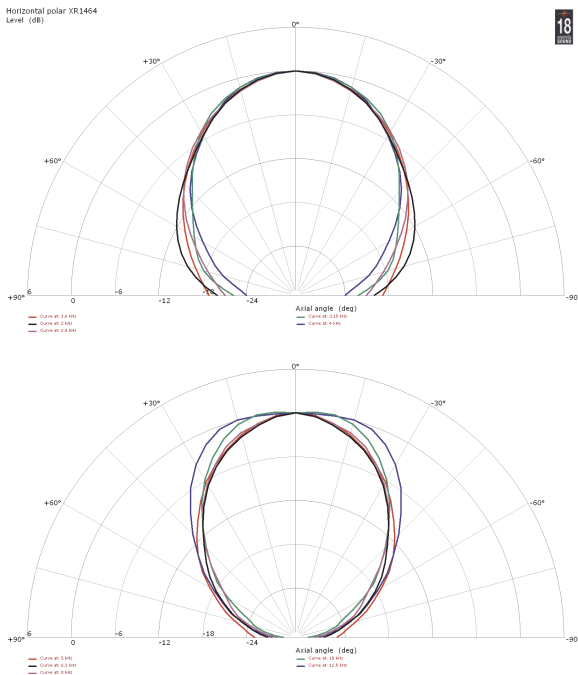

VERTICAL 1/3 OCTAVE POLAR PLOTS

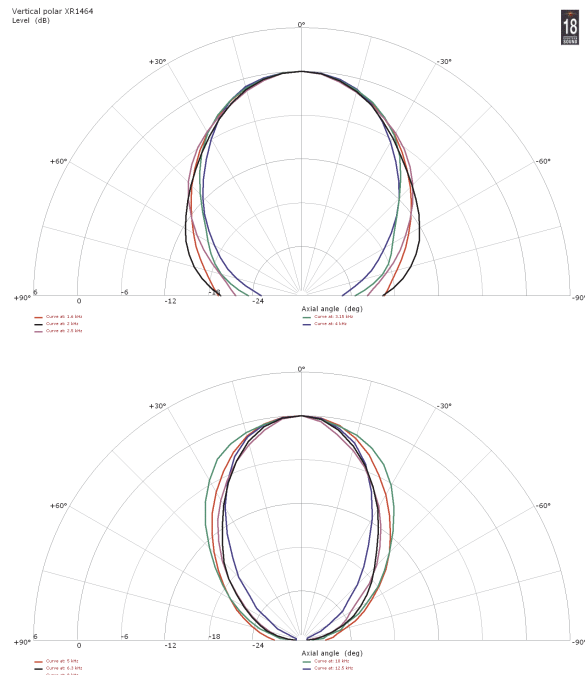

Eighteen Sound engages in research and product improvement. New materials and design refinements can be introduced into existing products without notice.

