

XR2064

Constant Coverage Horn

Key Features

- 2 inch throat entry
- Aluminum construction for excellent heat transfer
- Uniform on-axis and off-axis frequency response
- 60° x 40° horizontal and vertical constant coverage
- Very low distortion at high sound pressure
- Improved compression driver cooling
- Rotatable structure



General Description

The XR2064 is a constant directivity 2 inch horn. The XR2064 has been developed to reach the optimum performance when coupled to 2 inch exit Eighteen Sound high frequency compression drivers.

All XR series horns have been designed in order to reach smooth driver frequency response, to maintain constant coverage and directivity and eliminating the midrange narrowing and high frequency beaming problems common of many similar horns on the market.

XR2064 is made in low pressure injected aluminum in order to obtain the best performance in following aspects:

- thermal: aluminum horns are capable to reduce up to 30°C the steady state compression driver working temperature at full power, when compared to equivalent size plastic horn. This gives lower power compression ratio (down to 1dB) and higher driver power handling (30% higher);
- mechanical: aluminum horns do not require any support for the compression driver (likes brackets), and at the same time eliminate the problem of horn resonance with optimum waterfall and impulse system behavior.

The XR2064 horn maintains nominal 60° Horizontal x 40° Vertical pattern control. It provides consistent on-axis and off-axis frequency response from 1.2kHz to 16kHz in both horizontal and vertical planes.

Horn directivity is constant down to 1.2kHz.

0422064000

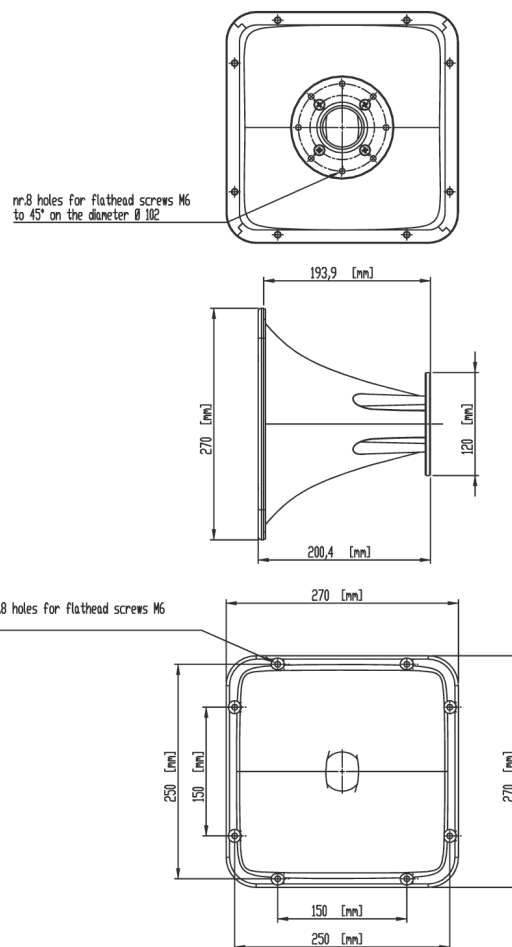

CONSTANT COVERAGE HORNS

XR2064

Constant Coverage Horn

CONSTANT COVERAGE HORNS

GENERAL SPECIFICATIONS

THROAT DIAMETER	50 mm (2 in)
HORIZONTAL COVERAGE (-6DB)	60° (10 ÷ -6) average range (1,6kHz - 12,5kHz)
VERTICAL COVERAGE (-6 DB)	40° (30 ÷ 0) average range (1,6kHz - 12,5kHz)
DIRECTIVITY INDEX	11 dB (1.8 ÷ - 2.6) average range (1,6kHz - 12,5kHz)
USABLE FREQUENCY RANGE	Above 800 Hz
RECOMM. CROSS.FREQUENCY	800 Hz or more
SENSITIVITY (ON AXIS) (1)	110 dB
FREQUENCY RANGE	800 Hz - 18kHz
HORN MATERIAL	Low pressure injected aluminum

MOUNTING INFORMATIONS

Mouth Height	270 mm (10,6 in)
Mouth Width	270 mm (10,6in)
Depth	200 mm (7,9 in)
Mouth Mounting Dimensions	8 ø 6 holes
Net weight	2 Kg (4,4 lb)

HORIZONTAL BEAMWIDTH, RED PLOT – VERTICAL BEAMWIDTH, BLUE PLOT – A

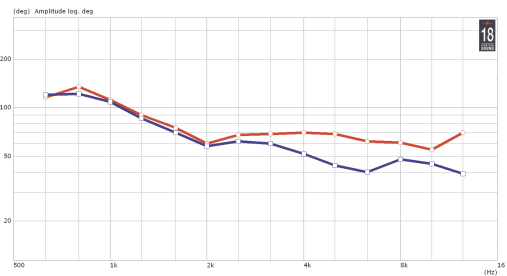

DIRECTIVITY INDEX – B

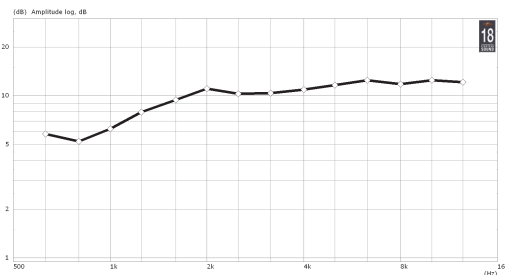

HORIZONTAL POLAR DIRECTIVITY MAP – C
VERTICAL POLAR DIRECTIVITY MAP – D

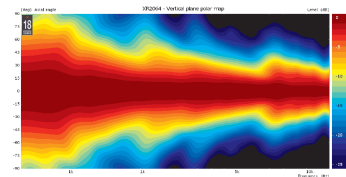
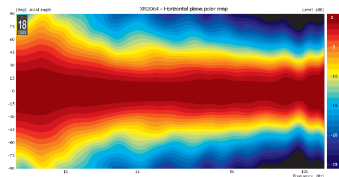

NOTES

(1) Sensitivity is measured at 1W input on ND2080 rated impedance at 1m on axis from the mouth of the horn, averaged between 1kHz and 4 kHz.

HORIZONTAL 1/3 OCTAVE POLAR PLOTS

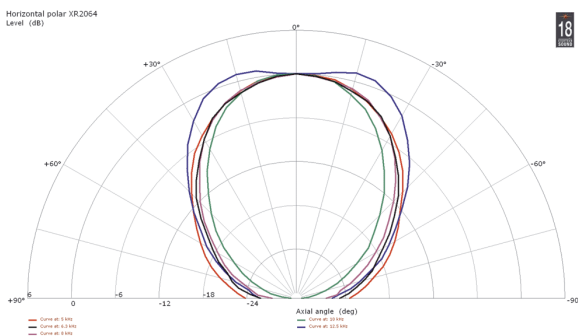
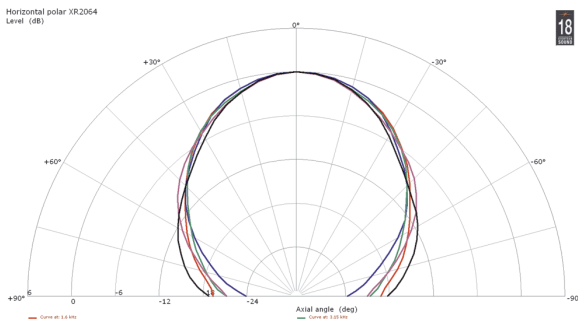

VERTICAL 1/3 OCTAVE POLAR PLOTS

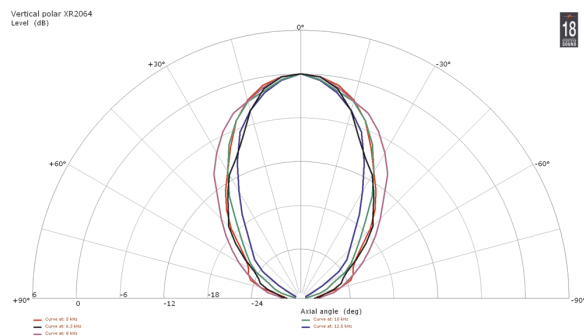
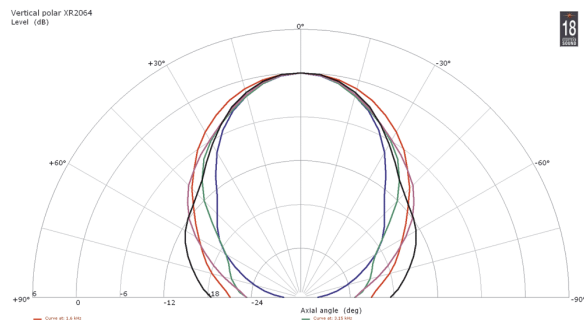

EIGHTEEN Sound engages in research and product improvement. New materials and design refinements can be introduced into existing products without notice.