

CLIO

ELECTRICAL & ACOUSTICAL TESTS

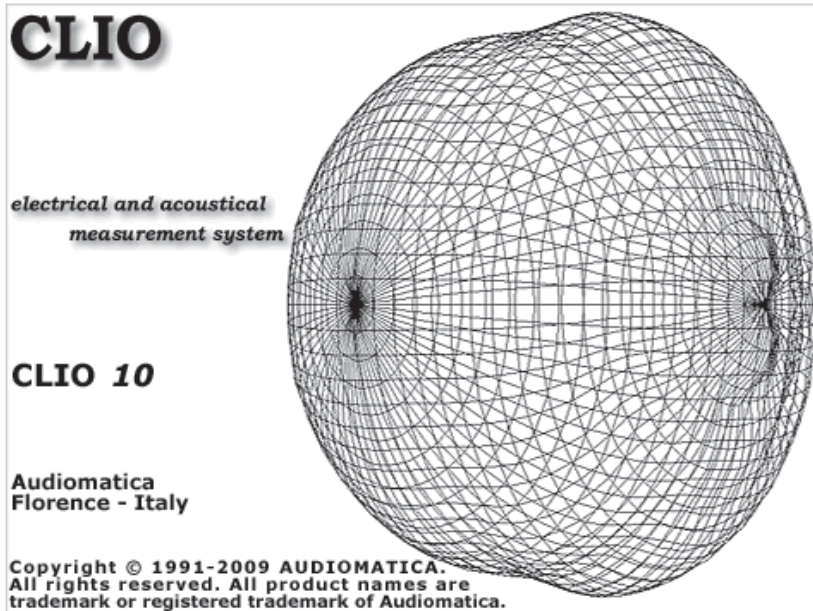

CLIO Software

Release 10
Quality Control Extension

User's Manual



© Copyright 1991–2009 by AUDIOMATICA SRL

All Rights Reserved

Edition 10.00, May 2009

IBM is a registered trademark of International Business Machines Corporation.
Windows is a registered trademark of Microsoft Corporation.

CONTENTS

19 QUALITY CONTROL	5
19.1 INTRODUCTION	5
19.2 FEATURES OF CLIO QC	5
19.2.1 THE OPERATOR'S POINT OF VIEW	6
19.2.2 THE ENGINEER'S POINT OF VIEW	8
19.2.3 THE COMPANY'S POINT OF VIEW	9
19.2.4 OPERATORS AND PASSWORDS MANAGEMENT	10
19.2.5 DIGITALLY SIGNED QC FILES	12
19.3 THE QC SOFTWARE OPERATION	13
19.3.1 THE REFERENCE FILE	15
19.3.2 THE LIMITS FILE FOR SINGLE CHANNEL MONO OPERATION	15
19.3.3 LIMITS FILE FOR TWO CHANNELS STEREO OPERATION	17
19.4 THE QC CONTROL PANEL	18
19.4.1 TOOLBAR BUTTONS	18
19.4.2 THE QC REPORT PANEL	21
19.4.3 REVIEWING A MEASUREMENT	21
19.4.4 THE QC RESULT PANEL	24
19.4.5 THE QC BANNER	24
19.4.6 QUALITY CONTROL MENU AND SHORTCUTS	25
19.4.7 QC REGISTERED FILE EXTENSIONS	26
19.4.8 QC OPTIONS DIALOGS	27
19.5 MY FIRST QC SCRIPT	28
19.5.1 WHAT TO KNOW ABOUT QC SCRIPTS	28
19.5.2 HOW TO WRITE MY FIRST QC SCRIPT	28
19.6 NOTES ON LIMITS CURVES	32
19.6.1 ABSOLUTE VS. RELATIVE FREQUENCY LIMITS	34
19.6.2 AVERAGE LEVEL CHECK	36
19.6.3 ALIGNED MASK	39
19.6.4 SENSITIVITY CHECK	40
19.6.5 FLOATING LIMITS VS. FLOATING CURVES	41
19.6.6 SINUSOIDAL A/B STEREO DIFFERENCE CHECK	42
19.6.7 SINUSOIDAL THD AND FAST-TRACK RUB&BUZZ CHECK	43
19.6.8 THIELE&SMALL PARAMETERS CHECK	44
19.6.9 LOUDNESS RATING CALCULATION AND CHECK	45
19.6.9 MULTIMETER LIMITS FILES	46
19.7 MANAGING PRODUCTION BATCHES	47
19.7.1 DIRECTORIES CREATED BY CLIO QC	47
19.7.2 PRODUCTION REPORT FILES	48
19.7.3 AUTOSAVED DATA FILES	49
19.7.4 STATISTICAL INFORMATION ON MEASURED DATA	49
19.7.5 SERIAL NUMBER MANAGEMENT	50
19.7.6 THE SKIP LAST BUTTON	51
19.8 INTERACTING WITH EXTERNAL HARDWARE	52
19.8.1 INPUT SENSITIVITY AND OUTPUT VOLTAGE CONTROL	52
19.8.2 QCBOX MODEL 5 DC OUTPUT CONTROL	52
19.8.3 CLIOQC AMPLIFIER&SWITCHBOX CONTROL	53
19.8.4 EXTERNAL TRIGGER	54
19.8.5 TTL SIGNALS GENERATION	55
19.8.6 TIME DELAYS GENERATION	57
19.8.7 PARALLEL PORT SIGNALS MANAGEMENT	58

19.8.8 QCBOX MODEL 5 DIGITAL I/O SIGNALS MANAGEMENT	59
19.8.9 RS-232 SERIAL PORT CONTROL	60

20 QC BY EXAMPLES, TCP-IP MEASUREMENT SERVER AND SYNTAX REFERENCE 61

20.1 A COMPLETE, FAST, SINGLE-TEST LOUDSPEAKER QUALITY CONTROL	61
20.1.1 HARDWARE REQUIRED	61
20.1.2 MEASURING THE REFERENCE FREQUENCY RESPONSE	63
20.1.3 MEASURING THE REFERENCE IMPEDANCE RESPONSE	66
20.1.4 INTEGRATING THE QC REFERENCE FILE	68
20.1.5 PROGRAMMING THE QC SCRIPT	69
20.1.6 RUNNING THE QC TEST	71
20.1.7 ADDING THE INTERFACE TO AUTOMATION	71
20.2 QC EXAMPLES	73
20.2.1 EXAMPLE 1: QC OF A MICROPHONE PREAMPLIFIER	73
20.2.2 EXAMPLE 2: THE AMPLIFIER&SWITCHBOX UNDER QC	76
20.2.3 EXAMPLE 3: A TEST ON A STEREO ELECTRONIC EQUIPMENT	78
20.2.4 EXAMPLE 4: A CYCLIC SCRIPT (USED TO MANAGE MY ROGERS LS3/5A TWO-WAY LOUDSPEAKER PRODUCTION)	79
20.2.5 EXAMPLE 5: QUALITY CONTROL OF A TELEPHONE WITH LOUDNESS RATING CHECK	82
20.2.6 EXAMPLE 6: ON RUB & BUZZ DETECTION (1)	83
20.2.7 EXAMPLE 7: ON RUB & BUZZ DETECTION (2)	85
20.3 CLIO QC TCP/IP SERVER	87
20.3.1 INVOKING THE QC SERVER	87
20.3.2 CONNECTING TO THE QC SERVER	88
20.3.3 INTERACTING WITH THE QC SERVER	89
20.3.4 NOTES ABOUT QC SERVICES	92
20.3.5 KEYWORDS FOR QC SERVICES	94
20.3.6 TCP SERVER EXAMPLE: A C++ CLIENT APPLICATION	95
20.4 QC SCRIPT SYNTAX REFERENCE	98
20.4.1 KEYWORDS FOR GENERAL SETTINGS	98
20.4.2 KEYWORDS FOR MEASUREMENTS SETTINGS	103
20.4.3 KEYWORDS FOR AUXILIARY TESTS AND MATH OPERATION	106
20.4.4 KEYWORDS FOR CONDITIONAL EXECUTION	107
20.4.5 KEYWORDS FOR HARDWARE CONTROL	111
20.4.6 OTHER KEYWORDS	112
20.4.7 KEYWORDS USED IN LIMITS FILES	113

BIBLIOGRAPHY 119

NORMS 121

19 QUALITY CONTROL

19.1 INTRODUCTION

The Quality Control software extension for CLIO is a powerful suite for executing state of the art production line testing.

CLIO QC implements all the measurement techniques found in the CLIO standard software adding a versatile script processor that handles the test sequence most appropriate for your needs.

CLIO QC is able to test the production of loudspeakers, drivers, microphones, amplifiers and any other electroacoustic device.

CLIO QC can interact with external hardware or production line controllers in addition to PC peripherals, computer networks or with custom written software to implement a fully automatic test line.

CLIO QC can be configured to act as a **measurement server**. It is possible to easily integrate the sophisticated QC measurement techniques of CLIO inside custom written applications. Interaction takes place with TCP/IP transfer protocol giving the possibility of remote control over a network.

19.2 FEATURES OF CLIO QC

CLIO QC is exceptionally powerful as it relies on the power of CLIO.

Here is a list of the parameters that can be calculated within each measurement:

Sinusoidal - Frequency response and impedance response (mono or stereo tests)

- Average (or single frequency) level
- Sensitivity (average or up to eight frequencies)
- Polarity
- Total harmonic distortion response
- Single harmonic response (from 2nd to 10th)
- Fast-Track Rub&Buzz response
- T&S parameters ($F_s, Q_t, Q_e, Q_m, C_{ms}, M_{ms}, M_{md}, V_{as}, B_1, dB_{SPL}, Z_{Min}$)
- Loudness Rating (RLR, SLR, STMR)

MLS&CHIRP- Frequency response or impedance response (mono tests)

- Average (or single frequency) level
- Sensitivity (average or up to eight frequencies)
- Polarity
- T&S parameters ($F_s, Q_t, Q_e, Q_m, C_{ms}, M_{ms}, M_{md}, V_{as}, B_1, dB_{SPL}, Z_{Min}$)
- Loudness Rating (RLR, SLR, STMR)

FFT - Frequency response with definable stimulus (mono tests, also interactive)

- Average (or single frequency) level
- Sensitivity (average or up to eight frequencies)

METER - SPL, Volts, THD, IMD single parameter (mono tests, also interactive)

The QC processor is able of handling **a virtually unlimited sequence of tests** to accomplish even the most complex tasks; on the other hand **a single ultra-fast sinusoidal test (read about it in 20.1)** may ensure you production **cycle times of less than 1 second** with total integration with the line controller.

Some of the QC management features are better explained starting from the various people taking part in this complex operation and their points of view:

- The operator working on the line (19.2.1)
- The quality control engineer responsible for production line operation (19.2.2)
- The company and its managers controlling the overall process (19.2.3)

All QC operations can be **password protected** (19.2.4); file operation can be restricted by their **digital signature** (19.2.5).

19.2.1 THE OPERATOR'S POINT OF VIEW

A quality control test can be controlled by simple Go-NoGo masks letting even the least experienced operator work without problems and with no learning curve.



Figure 19.1

A more complex operation foresees the continuous display of the measurements executed until the reaching of the final result.

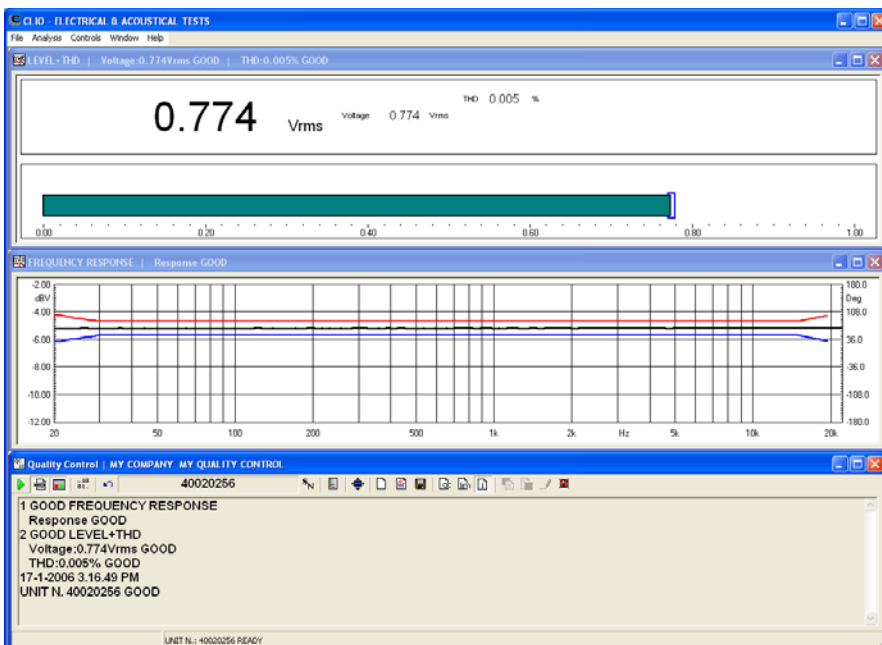

Figure 19.2

A third possibility is to view and interact with the test sequence during its execution.

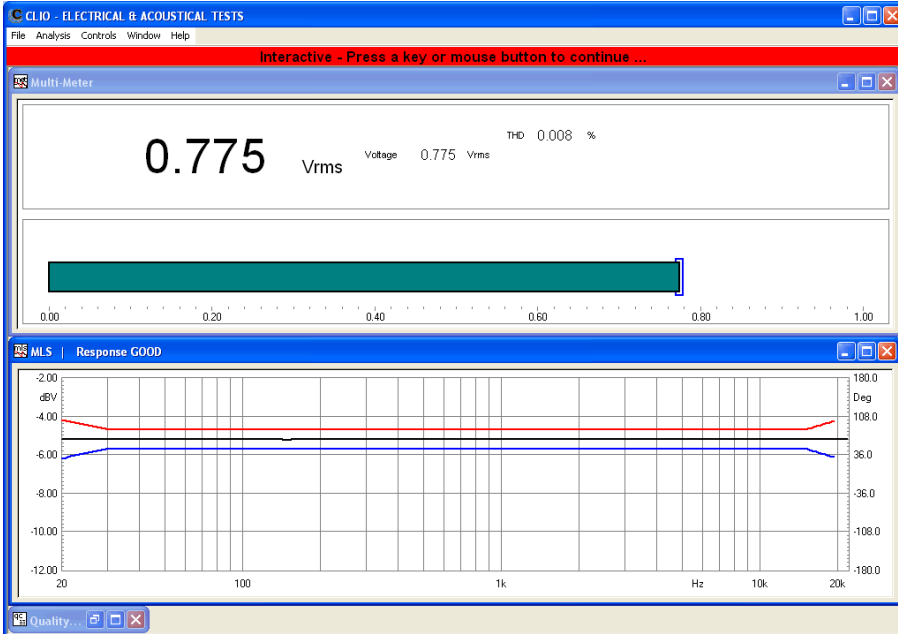

Figure 19.3

Completed test information and reports are always presented to the user.

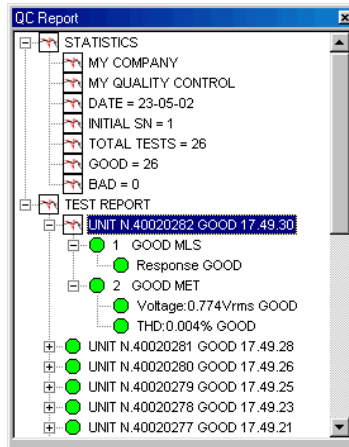

Figure 19.4

19.2.2 THE ENGINEER'S POINT OF VIEW

As the QC is integrated inside the CLIO software no new user interface has to be learned by the engineer who has experience of CLIO inside her or his research laboratory. A quality control test relies on real measurements saved on disk and on a simple text script.

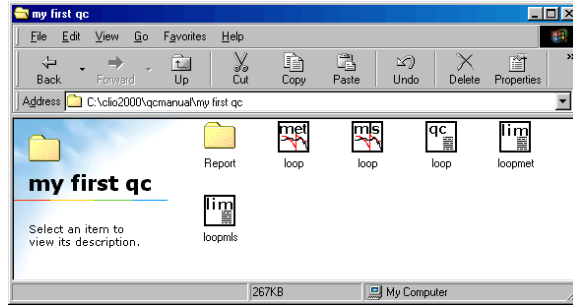

Figure 19.5

Defining a QC script is easy as it requires the writing only a few descriptive lines of text, no programming languages or complex instructions are involved.

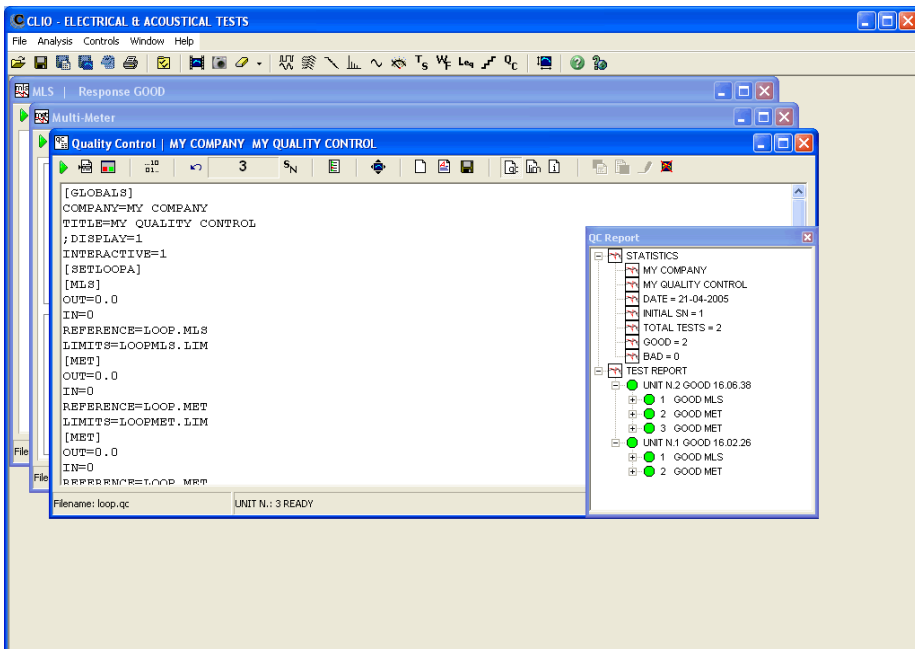

Figure 19.6

It is possible to capture the active measurement; the check masks can also be input in a visual manner drawing limits over the measurement; debugging is helped by an internal corrector.

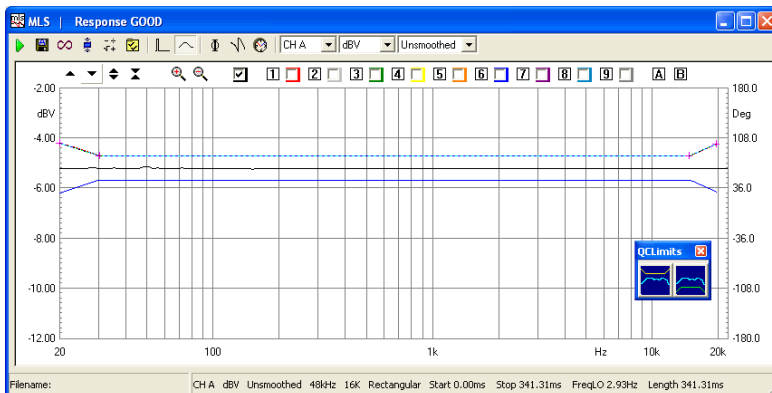

Figure 19.7

19.2.3 THE COMPANY'S POINT OF VIEW

CLIO when used for quality control executes line testing in a fast, accurate and reliable manner. Its flexibility permits easy handling of trade-offs between parameters like speed and accuracy always matching the company's needs. The autosaving and exporting capabilities together with the complete result reporting gives instant access to the production parameters and statistics even during its operation. The production batch is fully managed while preserving serial number coherence.

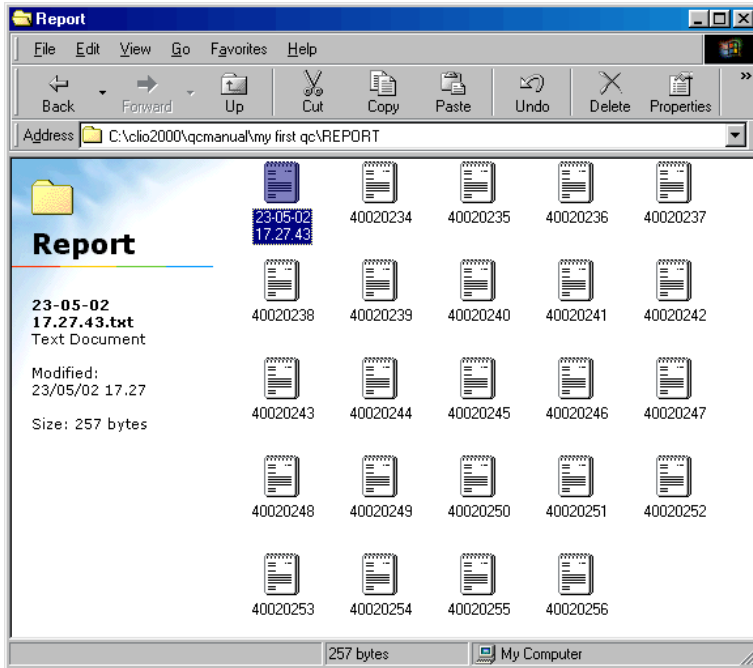

Figure 19.8

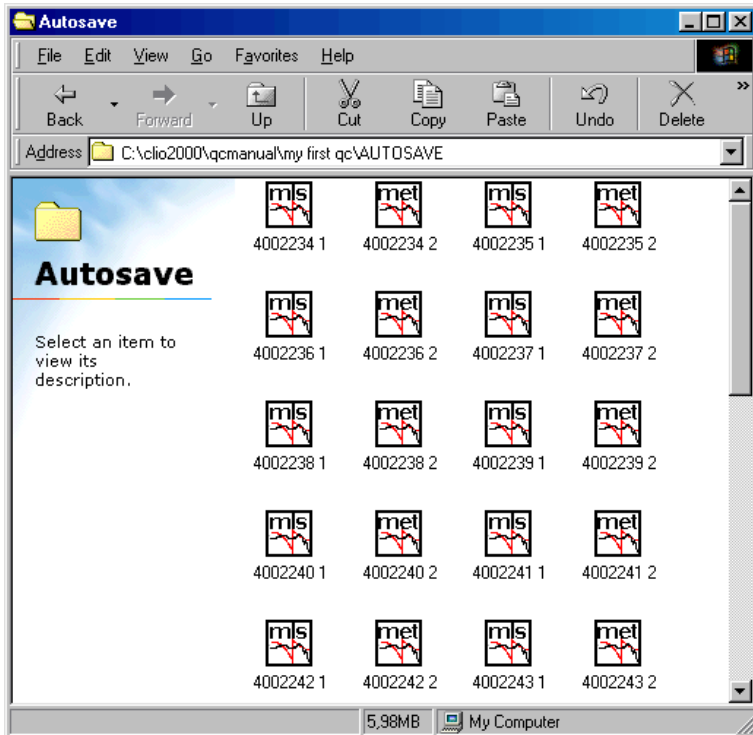
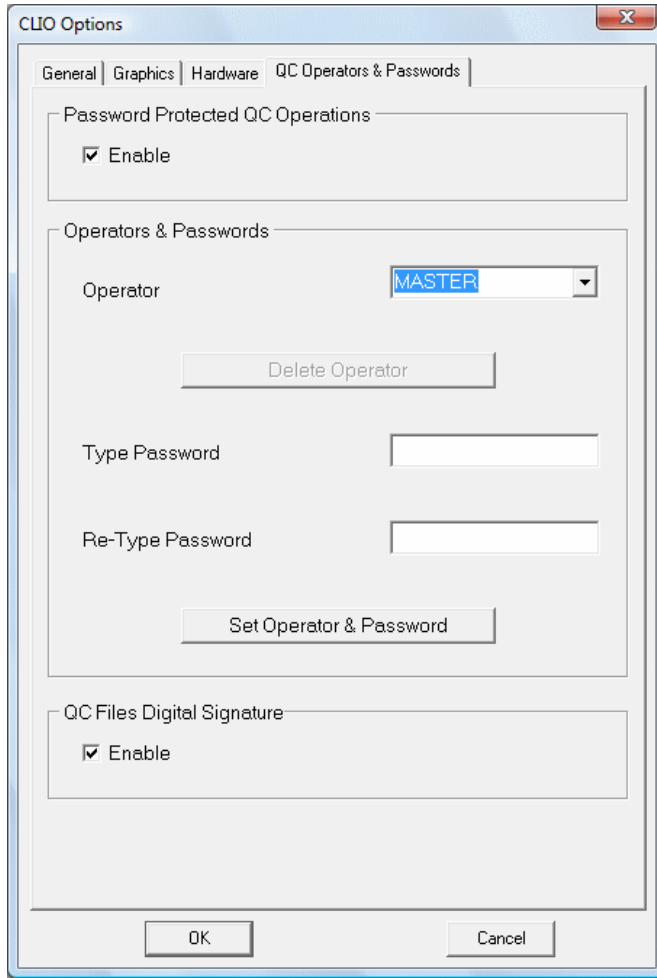

Figure 19.9

19.2.4 OPERATORS AND PASSWORDS MANAGEMENT

CLIOQC is capable of implementing a basic management for limiting operators access to QC functions. Operation is controlled under CLIO Options>QC Operators & Passwords.



It is also possible to digitally sign the quality control script to prevent users to manipulate it without permission.

ENABLING PASSWORD PROTECTED OPERATIONS

The QC processor has two default built in operators and relative passwords:

<i>name</i>	<i>password</i>
MASTER	'000000'
USER1	'user1'

To enable password protected operation you should invoke the CLIO Options dialog and access the 'QC Operators & Passwords' tab. Click on Enable:

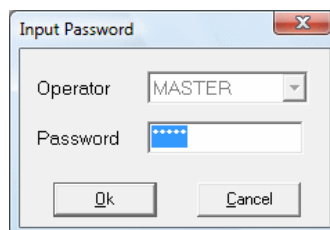

You will be prompted to access as MASTER operator.

The MASTER operator is the only entity to have full capability over all QC functions. It is the only operator that cannot be deleted. It is advisable to change its default password as soon as possible.

Inside CLIO Options it is possible to define new operators and relative passwords, modify or delete them. It is possible to define up to 100 different users.

It is also possible to activate operation only with digitally signed QC files (see later).

All settings relative to passwords and operators are crypted and saved inside the "qc.stp" file that resides in the CLIO's temporary folder (see chapter 5); deleting this file resets CLIO to the initial default situation.

THE OPERATOR'S POINT OF VIEW WHEN DEALING WITH PASSWORDS

Upon invoking the Quality Control menu it is given access only to registered operators.

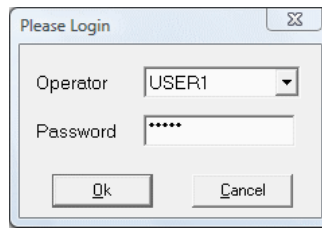

The same prompt is also given each time a new QC script is loaded from disk.

If digitally signed files operation is enabled only correctly signed files could be run, otherwise the following prompt appears:

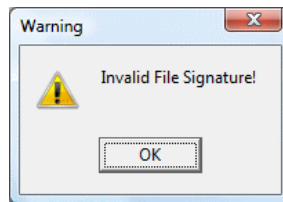

The QC operations are marked with the logged operator's name:

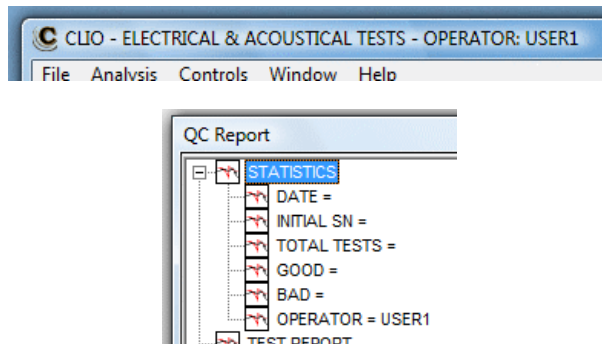

and her/his name is also saved inside reports.

An operator cannot force the result of a test (with the Skip Last function) unless supervisor (MASTER) consent is given.

19.2.5 DIGITALLY SIGNED QC FILES

The MASTER operator is capable of digitally signing the QC script and Limits file needed to run a quality control test. When this kind of operation is active all text files found in the test must be signed; usually you will need to sign the QC Script (.qc extension) and all the limits files (.lim extension) present in the test you want to protect.

To sign a file simply save it with MASTER credentials (i.e. logged as MASTER operator).

When you save a script or limit file under these conditions CLIO will also generate a digital signature that will be stored in a file saved inside the same folder.

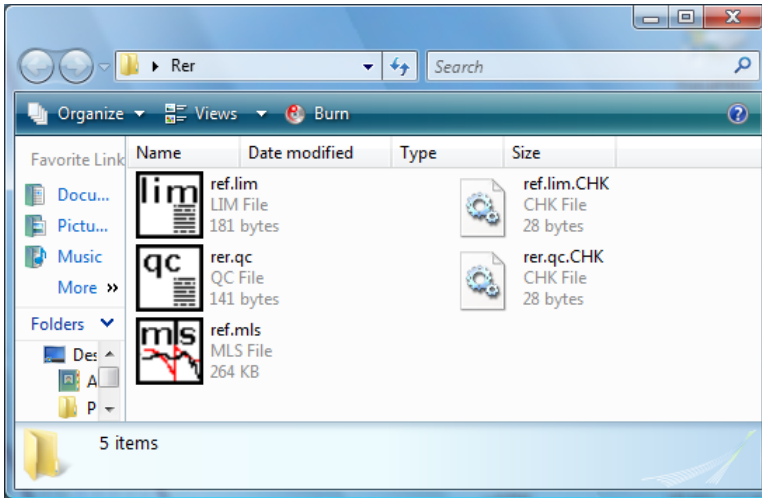

Aside the 'rer.qc' file there is its digital signature 'rer.qc.chk' file. In its absence the script cannot be loaded and run.

19.3 THE QC SOFTWARE OPERATION

The QC software is a "file driven" event processor that, in sequence, performs a number of user-defined measurements to test the quality of a production line. The text file ('.qc' extension) driving this process is called the **QC Script**.

CLIO's QC processor does the following job:

- reads the QC script and loads it in memory
- interprets it
- executes all the tests
- reports the test result and production statistics
- manages the production batch and serial number
- prompts for the next test

The following block diagram outlines the QC process.

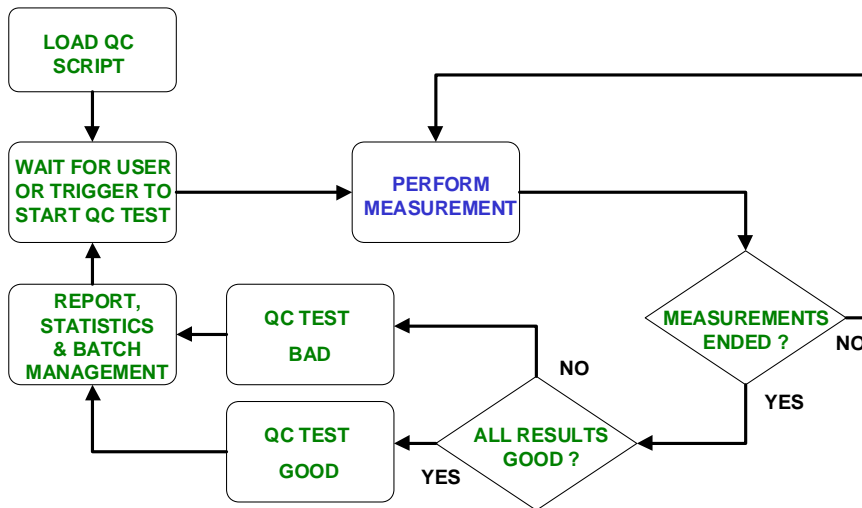

Figure 19.10

You can see the operation of loading the QC script from disk that begins our quality control session; then CLIO waits for that the user, or an external trigger (for example a TTL signal from the automation controller), to give the actual start to the QC test; the measurements defined are then executed in sequence until the last is reached; the result of the test is given by the sum of all the checks done inside the test sequence, it is only good if all checks gave a positive result; the QC test ends by updating the report and statistics while managing the production batch; the next device can then be put under test.

To proceed further it is advisable to go into the former block diagram in greater detail; this is done in Fig.19.11 and 19.12; Fig.19.11 zooms the entire QC test sequence adding the blocks in red, while Fig.19.12 zooms the "Perform Measurement " single block (the blue one).

Three different operating modes are outlined here: the DISPLAY mode, the INTERACTIVE mode and the DISPLAYONBAD mode.

If none of these modes are active the QC test proceeds without any measurements shown, with simple go-no-go masks, as in Fig.19.1.

If **DISPLAY** mode is active then the executed measurements are shown and remain on the screen for a definable amount of time, the test automatically proceeds until the end. Fig.19.2 depicts such a situation.

If **INTERACTIVE** mode is active the executed measurements are shown and then the software prompts for user input . The test sequence is not continued until the user executes a particular action or actions. It is also possible to loop certain measurements for D.U.T. tuning (see Fig.19.12). Fig.19.3 depicts such a situation.

If **DISPLAYONBAD** mode is active then the executed measurements are shown only if their result is not satisfactory. The sequence is stopped for user acceptance.

Fig.19.11 shows also the **Autosave** management which is of great importance for controlling the production and for characterizing a batch. This feature is completely user definable allowing for binary or text files, operation conditioned by the test result, coherence with serial number and single test number; the operator can also be prompted for file name input.

Two blocks are devoted to the execution of particular actions conditioned by the result of the single test or the result of all tests. Among these we find:

- messages to the operator
- printout of the measurement
- execution of custom written software
- generation of TTL signals to manage automatic lines
- pause for a predefined amount of time
- stop the sequence

The last red block, right before the end of the QC test, represents the **Cyclic Script**. The cyclic script is a particular sequence of QC operations described and saved in a script file that is executed regularly after a certain number of QC tests have been executed; this is useful for retesting reference quantities that characterize the entire process and maintain traceability to environmental conditions. The typical example is the reference loudspeaker tested every 100 production units have passes the QC test.

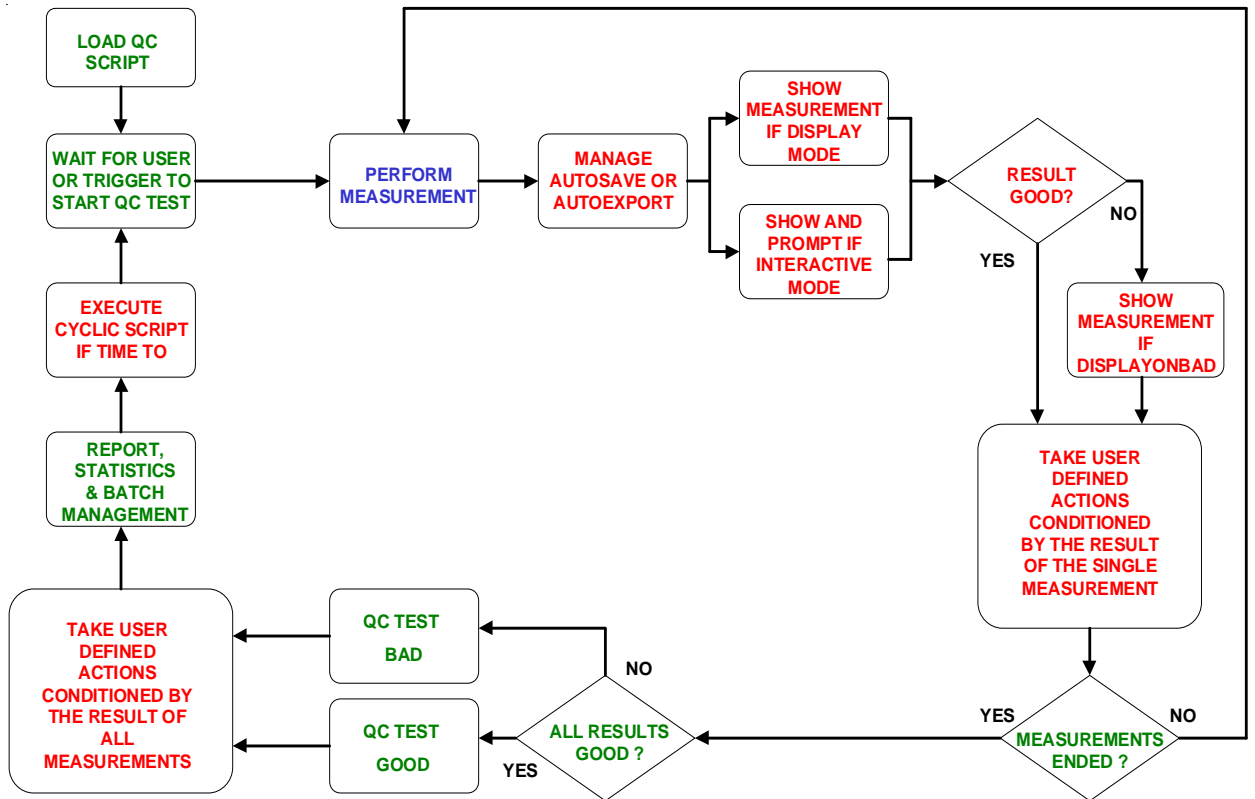

Figure 19.11

The third diagram in Fig. 19.12 shows us how the single QC measurement is performed. As outlined before, CLIO QC relies on the measurements present in the standard version of the software; the possible measurements within QC are: MLS ([**MLS**]), FFT ([**FFT**]), Sinusoidal ([**SIN**]) and Multimeter ([**MET**]). We will now cover the keywords which are used to define the tests inside the script.

To understand this operation we must define two files: the **Reference File** and the **Limits File**; these files are the heart of the QC operation, together the QC Script they contribute to define all the parameters of the single measurement.

19.3.1 THE REFERENCE FILE

The Reference File is a standard CLIO measurement file (extension '.mls', '.fft', '.sin', or '.met') created within its relative menu; it contains most of the settings needed to fully configure your measurement. Just as CLIO resets the measurement control panel to the settings of the file loaded from disk, the QC processor does the same job; in this easy but effective way of operating you will be sure that, for example, the sampling frequency of your QC MLS measure will be the one you chose, or the display settings will be the same as when you saved the reference file. And all this is defined, inside the QC script, with a **single** text line:

```
REFERENCE=myreferencefile.mls
```

where we imagined that you gave the name 'myreferencefile' to a saved MLS measurement.

One very important setting stored within the reference file is if the measurement is **mono** (only channel A acquired) or **stereo** (channel A and B acquired simultaneously).

19.3.2 THE LIMITS FILE FOR SINGLE CHANNEL MONO OPERATION

When you have taken a single channel mono measurement you define only one limits file.

The Limits File is a text file ('.lim' extension) defining the frequency mask or quantities needed to check the executed measurement. The syntax used is the same as the QC script. A Limits file can be as simple as:

```
[UPPER LIMIT DATA]
100          +5
500          +3
5000         +1
10000        +5
[LOWER LIMIT DATA]
100          -5
500          -3
5000         -1
10000        -5
```

In principle nothing else is needed to define the basic measurement; here is an example of a section of a QC script defining a MLS measurement:

```
[MLS]
REFERENCE=MYREFERENCEFILE.MLS
LIMITS=MYLIMITSFILE.LIM
```

An interesting keyword to add is COMMENT that let's you give a brief description of the QC test that will be output during the measurement and inside reports:

```
[MLS]
COMMENT=FREQUENCY RESPONSE
REFERENCE=MYREFERENCEFILE.MLS
LIMITS=MYLIMITSFILE.LIM
```

While performing a QC measurement CLIO can calculate more parameters from the data acquired and have these parameters to concur with the final result. As an example it is possible to make a polarity check within a MLS frequency response measurement or make a T&S parameters check within an impedance measurement. The following script adds the polarity check to the former MLS test.

```
[MLS]
REFERENCE=MYREFERENCEFILE.MLS
LIMITS=MYLIMITSFILE.LIM
POLARITY=1
```

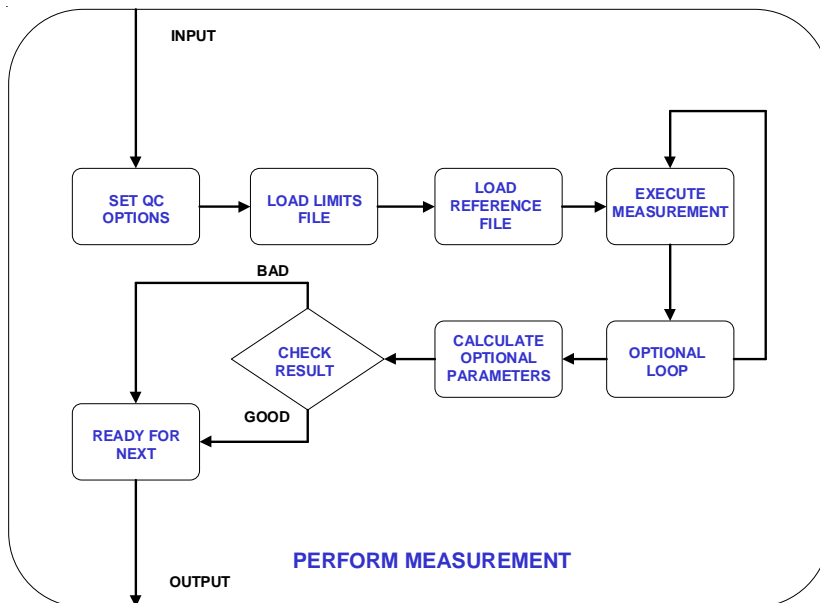

Figure 19.12

Here is a list of the parameters that can be calculated within each measurement:

- Sinusoidal - Frequency response and impedance reponse (mono or stereo tests)
 - Average (or single frequency) level
 - Sensitivity (average or up to eight frequencies)
 - Polarity
 - Total harmonic distortion response
 - Single harmonic response (from 2nd to 10th)
 - Fast-Track Rub&Buzz response
 - T&S parameters (Fs,Qt,Qe,Qm,Cms,Mms,Mmd,Vas,BI,dBSPL,ZMin)
 - Loudness Rating (RLR, SLR, STMR)

- MLS&CHIRP- Frequency response or impedance response (mono tests)
 - Average (or single frequency) level
 - Sensitivity (average or up to eight frequencies)
 - Polarity

- T&S parameters (Fs,Qt,Qe,Qm,Cms,Mms,Mmd,Vas,BI,dBSPL,ZMin)
- Loudness Rating (RLR, SLR, STMR)

FFT - Frequency response with definable stimulus (mono tests, also interactive)
 - Average (or single frequency) level
 - Sensitivity (average or up to eight frequencies)

METER - SPL, Volts, THD, IMD single parameter (mono tests, also interactive)

19.3.3 LIMITS FILE FOR TWO CHANNELS STEREO OPERATION

When you have taken a simultaneous two channels stereo measurement you may define the following limits files:

A) One single Limits file which is valid and shared for both channels; this is the case when both measurements refer to the same unit like the two channels frequency response of a headphone or of a stereo equipment. A stereo sinusoidal test may be defined as:

```
[SIN]
REFERENCE=MYREFERENCEFILE.SIN
LIMITS=MYSTEREOLIMITSFILE.LIM
```

B) Two different Limits files one per measured channel; this is the case when the two measurements refer to two different quantities like a frequency response together an impedance response. The LIMITS keywork, in this case, is substituted by the two keywords **LIMITSA** and **LIMITSB**. A stereo sinusoidal test may be defined as:

```
[SIN]
REFERENCE=MYREFERENCEFILE.SIN
LIMITSA=MYRESPONSELIMITSFILE.LIM
LIMITSB=MYIMPEDANCELIMITSFILE.LIM
```

19.4 THE QC CONTROL PANEL

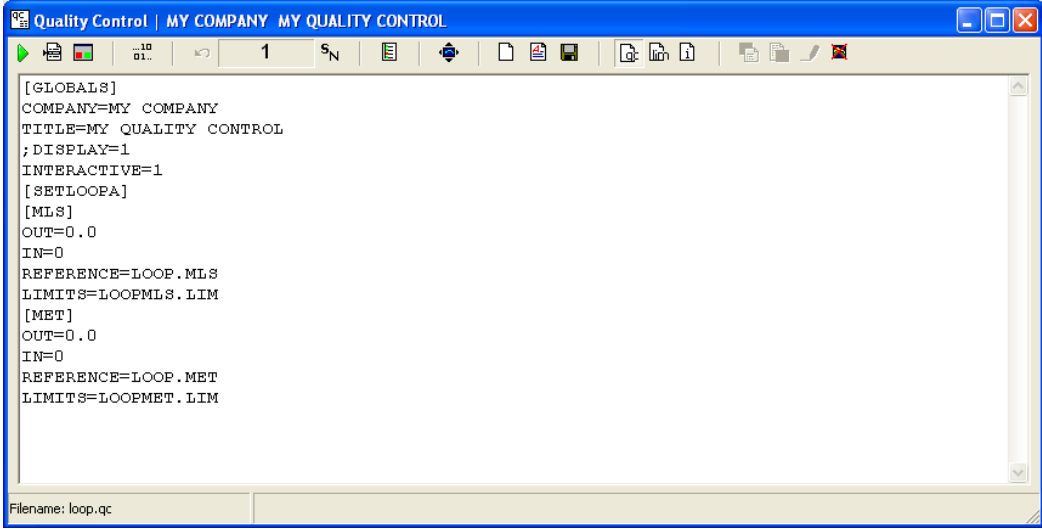





Figure 19.13

Figure 19.13 shows the Quality Control panel that is composed by a toolbar similar to the other CLIO panels plus a text display area that is used either for editing the QC files (QC script and Limits file) or for showing information about the QC test.

When the QC display handles file editing it has a white background while, when showing information, it is lightly colored.

19.4.1 TOOLBAR BUTTONS

-  Starts a QC test.
-  Enables tracing of the QC script during execution. If pressed, during test execution the QC control panel is not minimized and remains visible showing the current script section under execution.
-  Forces the QC result panel to be displayed after tests completion. Refer to 19.4.3 for more details.

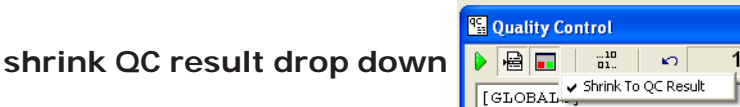

shrink QC result drop down

With this choice in the drop down menu associated with the QC result button it is possible to display a minimized version of the QC Result Panel; see 19.4.4.

-  Enables external trigger. This button overrides the setting in the script (**MANUAL** keyword). See 19.8.2 and the commands reference for more details.

-  Skips the last measured unit.

-  Used to input the current device serial number.

-  Recalls the QC Report panel Refer to 19.4.2 for more details.

Releases all the measurement control panels. Each panel reverts to its normal appearance. In fact, when a QC test sequence is running, each panel 'loses' its toolbar, overlay and curve controls and status bar in order to maximize the graph display when the windows are tiled. Fig.19.14 shows the MLS control panel in the two different situations.

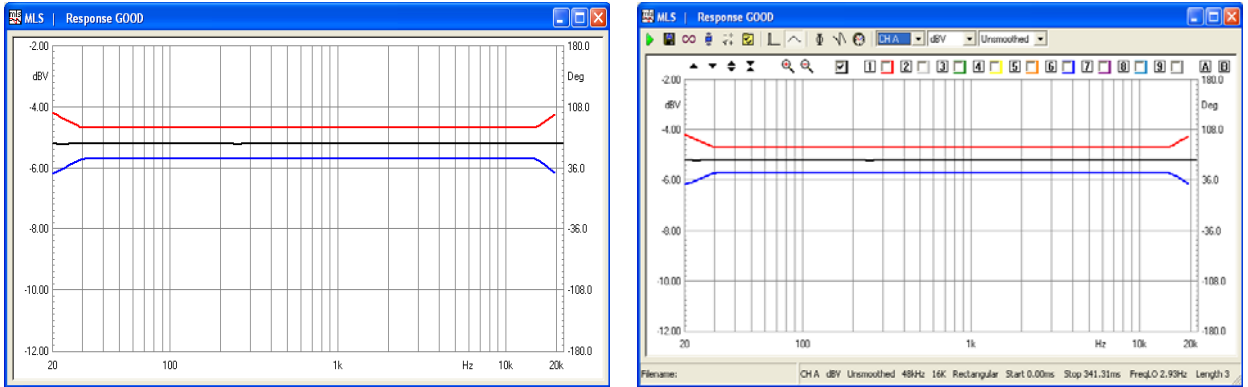









Figure 19.14

When control panels are managed under QC the title of the window is used to display the result of the parameters that have been measured or calculated: in Fig.19.15 we see written 'Response GOOD' which reports the result of the MLS frequency response check done.

-  Starts a new QC script editing session. The text present is cancelled.
-  Edit the current text.
-  Immediately saves the current text as Script or Limits file.
-  Enters the **Script Text mode**. The QC display presents the currently loaded QC script file.
-  Enters the **Limits Text mode**. The QC display presents the currently loaded Limits file.
-  Enters the **Information Text mode**. During tests the QC display shows the current QC script section under execution. When the test sequence is finished the QC display shows information about the executed tests.
-  If in **Script Text display mode**, 'captures' the active measurement generating a 'piece' of script file relative to the currently loaded reference and limits files. The text is inserted at cursor position. As an example the following text is generated in the assumption that you have MLS open with the active measurement saved as 'myreferencefile.mls' and that you have loaded the 'mylimitsfile.lim' inside QC; also captured are output level and input sensitivity (here assumed to be 0dBu and 0dBV respectively).

```
[MLS]
OUT=0.0
IN=0
REFERENCE=MYREFERENCEFILE.MLS
LIMITS=MYLIMITSFILE.LIM
```

If in Limits Text display mode, 'captures' the limits file of the active measurement loading it inside the QC display.

 Creates the frequency curves relative to the limits file under editing and shows them in the active measurement control panel.

 Enables the Draw Limits controls that let you visually input the frequency limits directly drawing on the active measurement control panel. Fig. 19.15 shows the MLS control panel with the Draw Limits controls on the top. Clicking on one of the two buttons starts drawing the relative limit curve; to finish input **double-click** on the last frequency point.

Note: it is mandatory to input points from left to right.

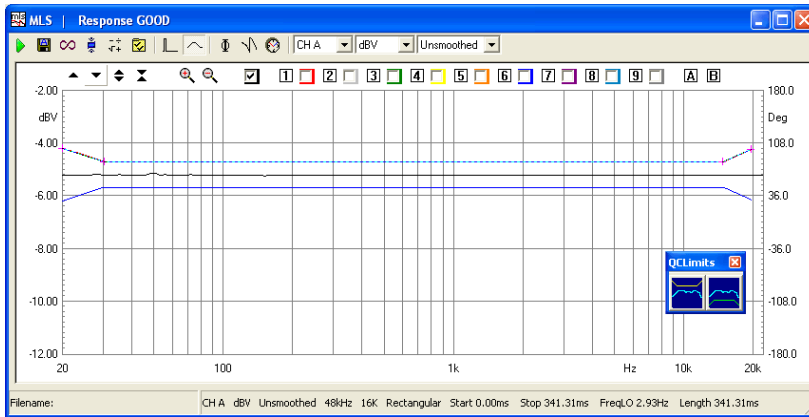



Figure 19.15

 Hides (if visible) or shows (if hidden) the limits curves in the active measurement control panel.

19.4.2 THE QC REPORT PANEL

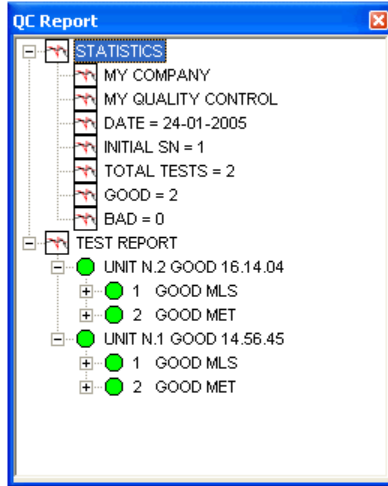

Figure 19.16

The QC Report panel serves as an interactive tool which is of great help for inspecting a production while it is tested; it is composed by two tree views named **STATISTICS** and **TEST REPORT** these handle all the information pertaining to your QC session in a very compact form.

The QC Report panel can be kept open during the tests and it accompanies the work in a really effective visual form.

Under **STATISTICS** you find information about:

- QC test and Company names
- Date of the first unit tested
- Name of the production batch
- First serial number tested
- Total number of units tested, number of "good" and "bad" units

Under **TEST REPORT** you find information about:

- DUT test result with serial number and time of production
- Single tests results
- Names of the saved files

The QC Report panel is also the starting point for reviewing a saved measurement as described below. The name of the saved file is a sensible area where you can double-click to review the measurement.

19.4.3 REVIEWING A MEASUREMENT

During a QC tests session it is possible to review a measurement that has been saved to disk. This is important when, for example, trying to understand why a measurement went bad. As we saw before the QC report panel indicates all the names of the files that have been created during the test execution, under the relative serial number and single test number.

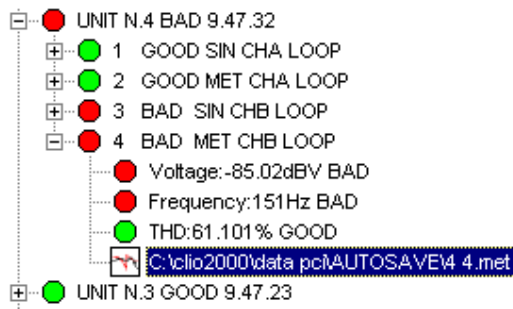

Figure 19.17

As soon as a QC sequence is terminated simply open the tree view of your interest, identify the measurement you want to inspect and double click on its name (Fig.19.17). CLIO loads the measurement as if it were performed inside the running QC, together with its pertinent limits and executes all the calculations defined in the QC script ending with the result check and display. Fig.19.19 describes such a process; compare it with Fig.19.12.

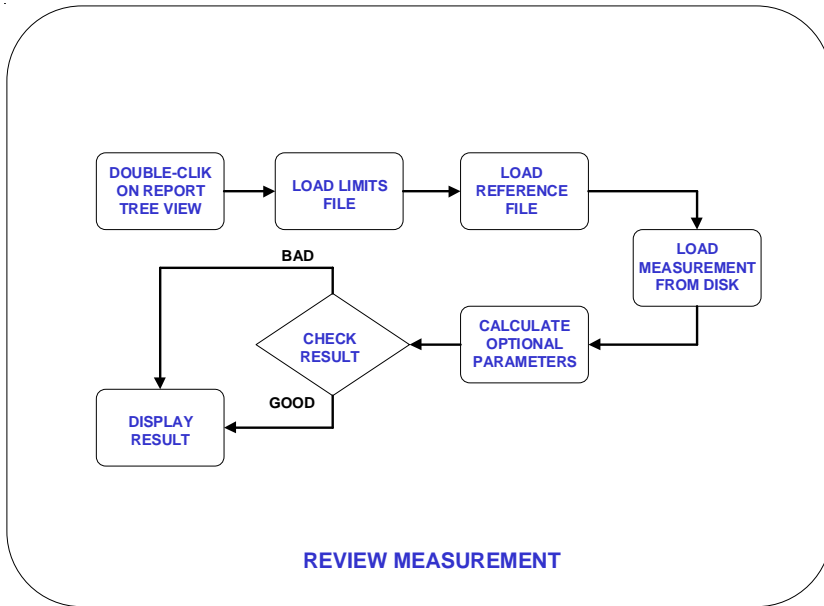

Figure 19.19

Reviewing a saved measurement from within QC is different from simply opening the file from the measurement control panel; in this second case no post processing due to QC operation is applied. Fig. 19.19 shows a measurement (black curve) reviewed inside QC with its limits (red and blue curves) and the same measurement loaded from the measurement control panel (purple curve); the shift in level is due to QC operation when it separately checks for relative level and frequency behavior.

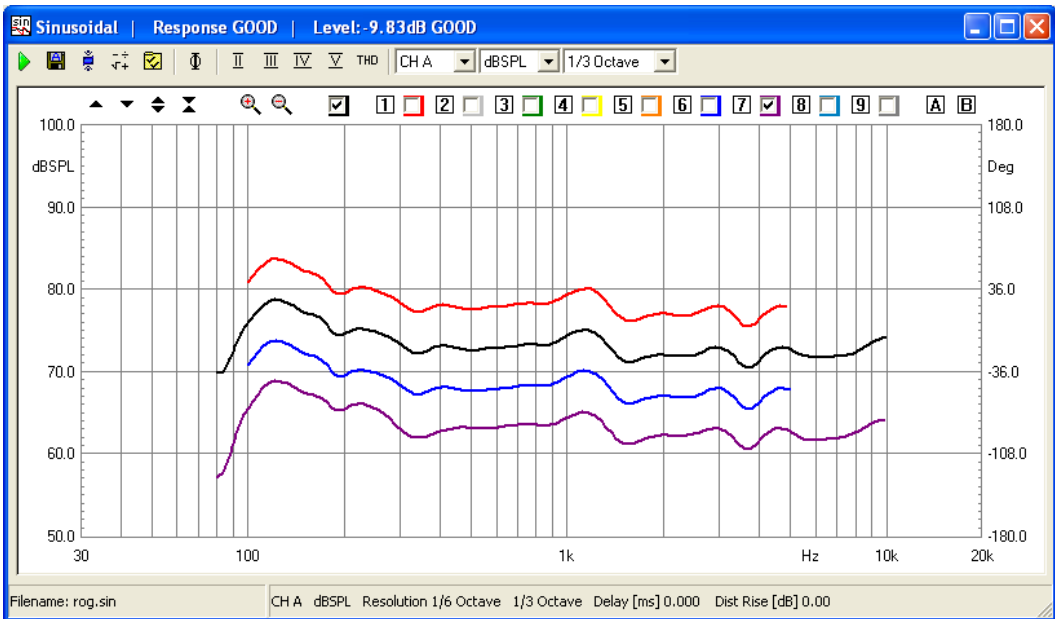

Figure 19.19

Note: the review operation can be done only when inside a QC session; if CLIO is exited, then later QC is started again a new QC session will be created; report information and review operation will only apply to the new session.

19.4.4 THE QC RESULT PANEL



Figure 19.20

The QC Result panel usually accompanies QC sessions where measurement display is not needed. This results in a situation with simple go-no-go masks for use with completely automatic lines or for operators who don't need to take particular actions with respect to the test result.

To activate the QC Result panel from within the QC script use the DISPLAY=0 keyword.

Note: for maximum QC test speed use the QC Result display and don't show single measurements as the display of graphical objects and measurement curves usually employs a lot of processor time.

The QC Result panel can be forced to appear at the end of the QC sequence pressing the  button.

If Shrink QC result is selected in the associated drop down menu the QC result panel will appear in a minimized version.

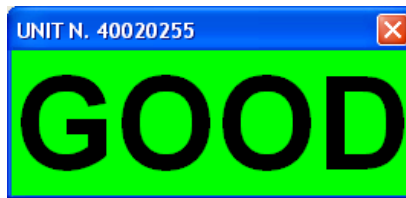

19.4.5 THE QC BANNER

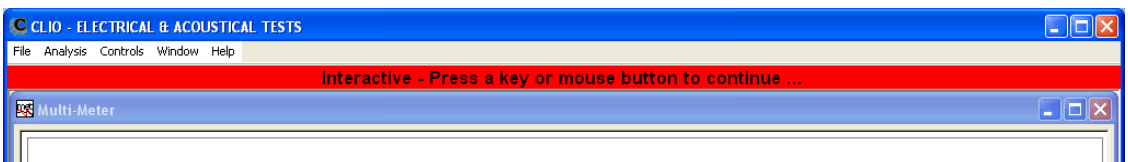

Figure 19.21

The QC Banner is managing information and messages given to the operator while in Interactive mode.

19.4.6 QUALITY CONTROL MENU AND SHORTCUTS

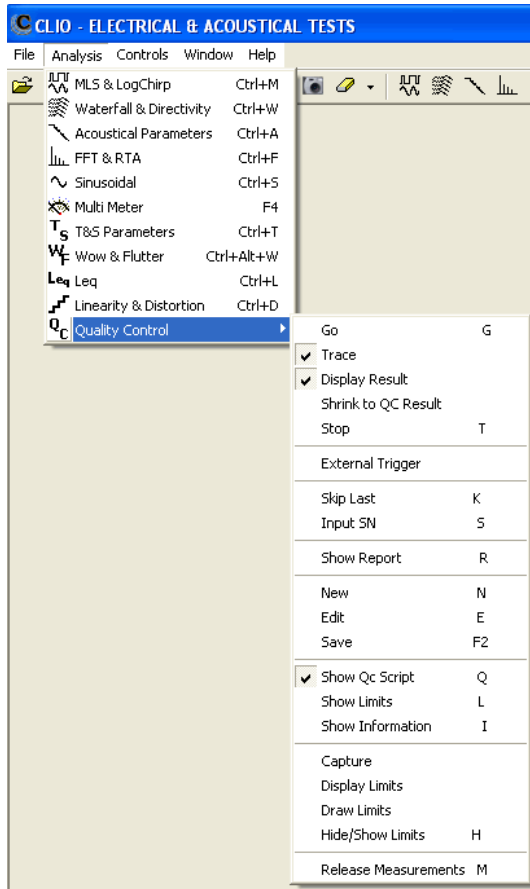

Figure 19.22

Figure 19.22 shows the Quality Control menu accessible from the Analysis menu. Seen below is a list of all the available Hot Keys.

ESC or T

Exits the QC test sequence.

End

Exits the QC test sequence in Interactive mode.

SpaceBar

Continues the QC test sequence in Interactive mode.

G Starts a QC test. Equivalent to .

K Skip last executed measurement. Equivalent to .

S Input serial number. Equivalent to .

R Show Report. Equivalent to .

N New QC script. Equivalent to .

E Edit QC script. Equivalent to .

F2 Saves QC script. Equivalent to 

CTRL-E

Ends an editing session, while inside the text display.

CTRL-C

Copy selected text.

CTRL-V

Paste selected text.

CTRL-X

Cut selected text.

CTRL-Z

Undo/redo text input.

Q Show QC script. Equivalent to 

L Show Limits. Equivalent to 

I Show Information. Equivalent to 

H Hide Limits. Equivalent to 

M Release measurements. Equivalent to 

19.4.7 QC REGISTERED FILE EXTENSIONS

CLIO Quality Control registers the following files extensions beyond the ones already registered by CLIO.



QC script files.



QC Limits files.

19.4.8 QC OPTIONS DIALOGS

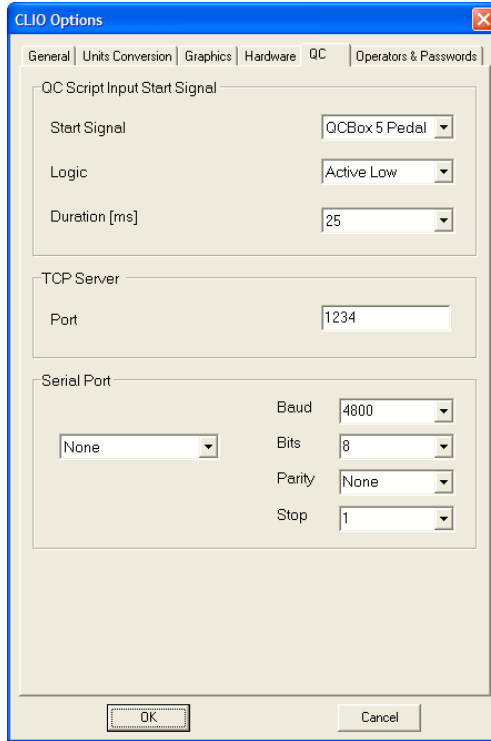

Under CLIO Options>QC you may define the following:

QC Script Input Start Signal

The external trigger signal or condition to start the QC (see 19.8.4).

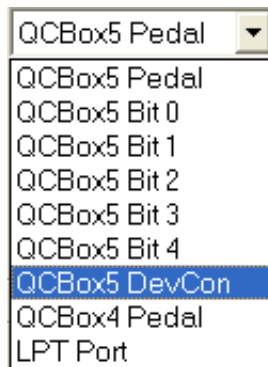

It is possible to trigger the QC tests sequence with the following:

- 1) A foot pedal switch connected to QCBox (Model 4 or 5) Pedal In connector.
- 2) The connection of the loudspeaker under test sensed by QCBox Model 5.
- 3) An external TTL signal wired to one of the QCBox Model 5 input.
- 4) An external TTL signal wired to the PC parallel printer port.

Note: For fastest operation when using QCBox Model 5 input use bits 2, 3 or 4. Bits 0 and 1 requires minimum 100ms duration.

TCP Server

The listening port of the TCP server (see 20.2).

Serial Port

A serial port to be controlled by QC (see 19.8.8).

19.5 MY FIRST QC SCRIPT

19.5.1 WHAT TO KNOW ABOUT QC SCRIPTS

A quality control script is a text file that stores information in logical groupings, called **sections**.

Each section is initiated by a bracketed keyword in the form **[keyword]**.

Within each section, QC definitions are stored in named keys.

Keys within a section take the form **keyword=value**.

For example the section called [GLOBALS] defines several settings useful all along the test sequence:

```
[GLOBALS]
COMPANY=MY COMPANY
TITLE=MY QUALITY CONTROL
BATCH=MY PRODUCTION BATCH NAME
```

It is possible to input comment lines initiated by a **semicolon**. It is **not** possible to start a comment after a keyword.

```
;this is a correct comment line
COMPANY=MY COMPANY ;this comment is not allowed
```

With an understanding of these brief notes you are ready to write a QC script.

19.5.2 HOW TO WRITE MY FIRST QC SCRIPT

You may write your script with any text editor that stores plain ASCII files (usually '.txt' ones), like Notepad; the only thing you should remember is that QC scripts must have the '.qc' extension while limits files use the '.lim' extension; the common behavior of Windows to hide registered file extensions sometimes renders this action difficult. It is not uncommon to believe you have saved a file with, say, the name 'myfile.qc' (where you tried to force the extension) and then find it actually saved as 'myfile.qc.txt' because the text editor automatically appended the registered extension.

You may write your script directly by editing it within the QC control panel text display; in this case the extension management is guaranteed by CLIO and you will be able to use some tools, like measurements capture, that are of help during everyday jobs. By doing it like this it is possible to immediately test the script by pressing Go.

Let's now write our first QC script.

Have your CLIO system in the same setup as when you performed the system calibration: output A connected to input A; see chapter 3 for details. Don't connect any external device to the system. Set output level at 0dBu and input sensitivity at 0dBV (see Chapter 4 for details). Have the default settings loaded.

Open MLS; press Go. You should obtain a straight line as in Fig. 19.23. Expand the display to obtain 2dB/div and set upper Y scale value to -2dBV. Save this measurement as 'Loop.mls'.

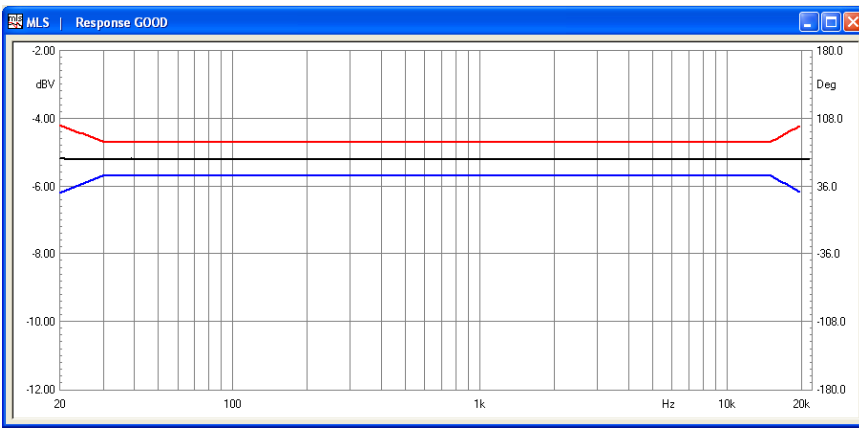



Figure 19.23

Now open the QC control panel. Press **N**, we are starting a new script. Press **Ctrl-E** to exit edit mode and then press **L** to enter Limits Text mode. Input the following frequency masks as limits:

```
[UPPER LIMIT DATA]
20          -4.2
30          -4.7
15000      -4.7
20000      -4.2
[LOWER LIMIT DATA]
20          -6.2
30          -5.7
15000      -5.7
20000      -6.2
```

Press **F2** and save the limits file as 'loopmls.lim'. Now click now on the  (script) button and then click on the  (capture) button. Your blank text display should now be filled with your first QC script:

```
[MLS]
OUT=0.0
IN=0
REFERENCE=LOOP.MLS
LIMITS=LOOPMLS.LIM
```

It is a good practice to add the following comment line:

```
COMMENT=FREQUENCY RESPONSE
```

Click on the  go button; the QC processor should execute a QC test performing an MLS measurement, displaying it together with the defined limits, everything as in Fig.19.24; the text display should now present information on the executed test.

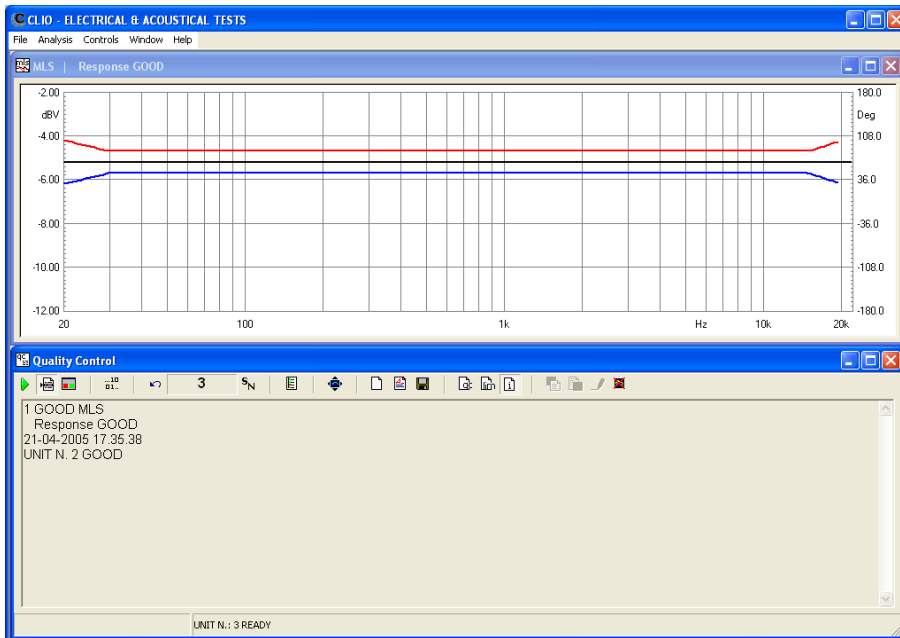



Figure 19.24

Let's now complete this first exercise by adding a Multimeter measurement of level and total harmonic distortion at 1kHz.

Press **F4** to open (and run) the Multimeter control panel, then click on the  generator button to switch the generator on and play the default 1kHz sinusoid. Now press **T** to stop measuring; save this measurement as 'loop.met'; Fig.19.25 should be what you have in front of you.

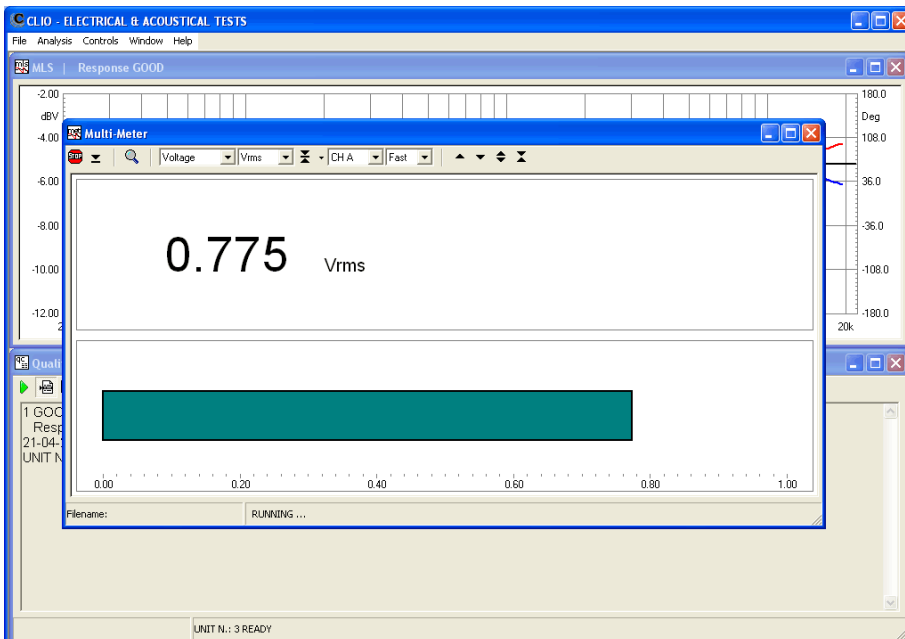



Figure 19.25

Now press **Ctrl-Q** and then **L** to go back to inputting a limits file definition. Input the following:

```
[UPPER LIMIT DATA]
VOLTAGE=0.78
THD=0.01
[LOWER LIMIT DATA]
VOLTAGE=0.77
THD=0.0001
```

Save this as 'loopmet.lim'. Now click on the  button and position the cursor inside the text display after the last line of text; as before, click on the capture button and the following lines should be added and you are ready for this new QC test.

```
[MET]
OUT=0.0
IN=0
REFERENCE=LOOP.MET
LIMITS=LOOPMET.LIM
```

It is a good practice to add the following comment line:

```
COMMENT=LEVEL+THD
```

Now pressing the Go inside QC executes this two-measurement QC test sequence; Fig.19.26 shows the test at its end.

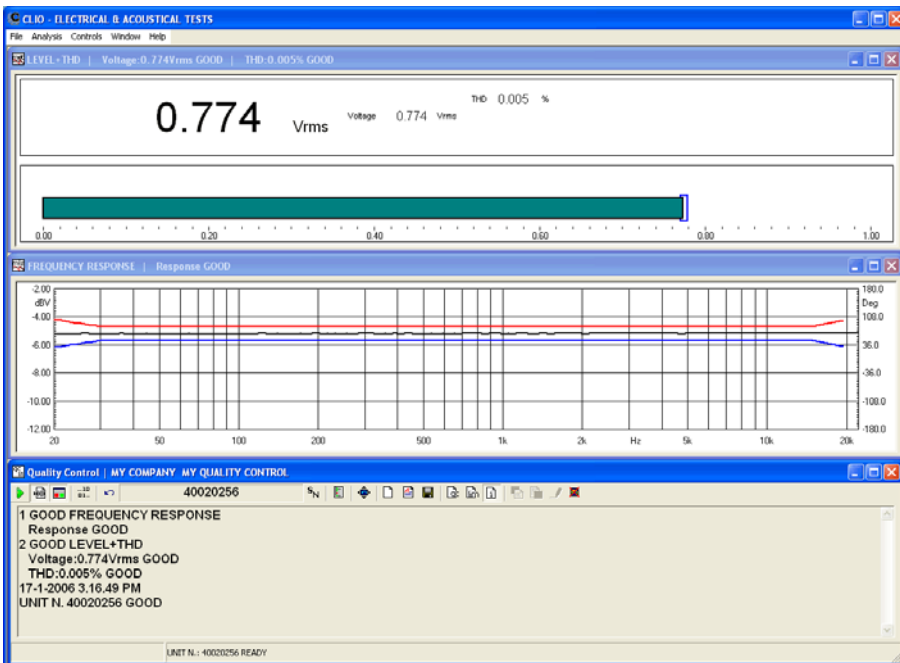

Figure 19.26

This concludes our first approach to QC script writing and debugging. All the files necessary to "study this lesson" are furnished within the 'My Documents\Audiomatica\CLIO 10 EXAMPLES\MY FIRST QC' folder.

The 'loop.qc' script is doing exactly what has just been described with a difference: measurements are performed in **interactive mode**; just load it and run it to feel the differences.

19.6 NOTES ON LIMITS CURVES

As previously outlined the QC processor needs limits data in order to perform the required checks. This data is saved within the limits files and usually represent a frequency mask (for frequency response and impedance tests) but they can also define a single value check (like, for example, a Qms test).

When dealing with frequency checks the options defined affect the way the frequency masks are calculated, the way data is displayed on screen and the way that the result is checked. It is also possible to add an average or single frequency level check that concurs with the final result.

Fig. 19.27 shows us the procedure for calculating the frequency mask after the limits file is loaded into memory. You can see that the frequency data sets saved under [UPPER LIMIT DATA] and [LOWER LIMIT DATA] are treated differently if the limits are absolute or relative (see 19.6.1) or if an aligned point is defined (see 19.6.3).

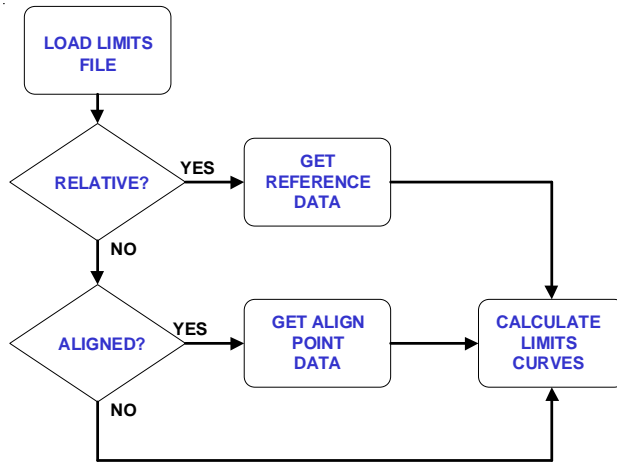

Figure 19.27

Fig.19.28 shows us the way a frequency check is performed and the measurement is presented on screen. You may appreciate the presence of an average level (or sensitivity) check (see 19.6.2) or a single point (aligned) level check (see 19.6.3) that concurs with the final result. **When a level (or sensitivity) check is defined, either the measured curve or the limits curves are shifted if presented on screen;** in this way it is possible to appreciate the frequency behaviour of the measured curve without the effect of a difference in sensitivity which is checked separately.

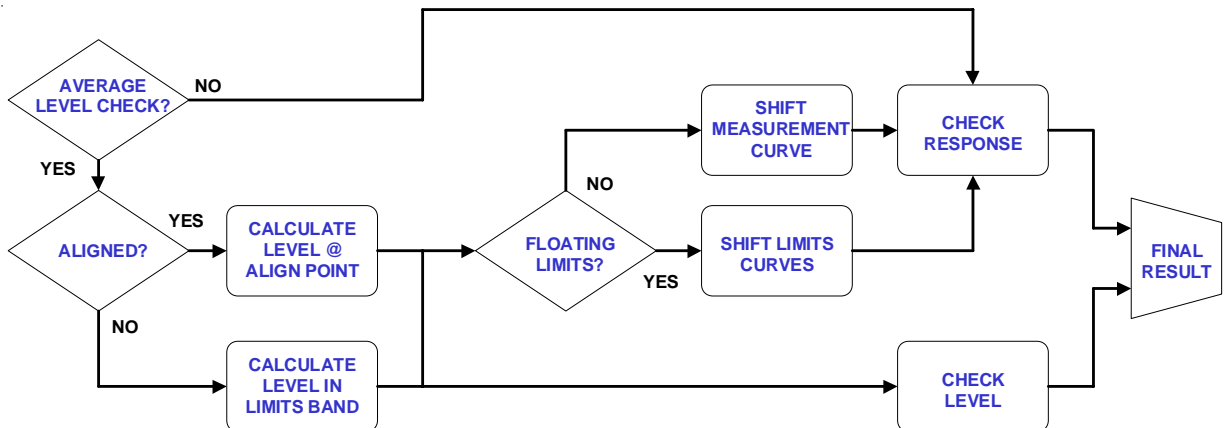

Figure 19.28a frequency plus average level check

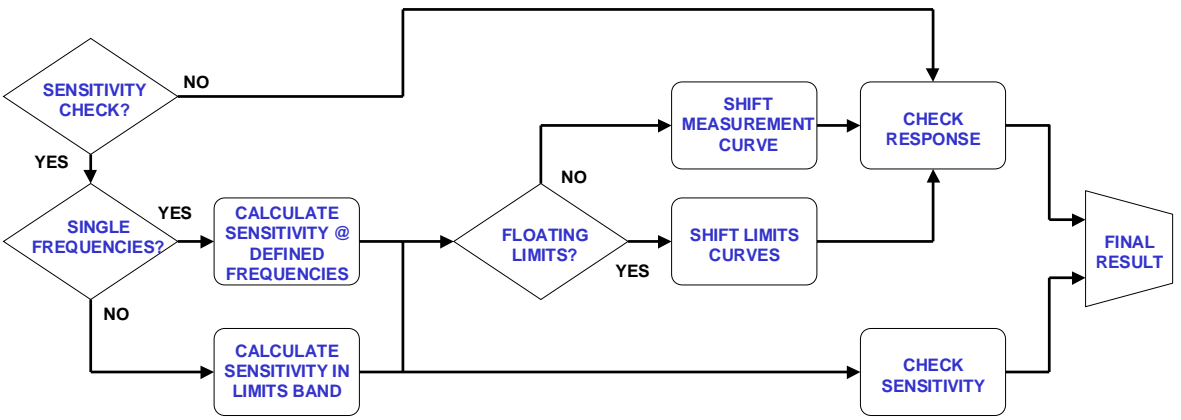

Figure 19.28b frequency plus sensitivity check

As a final, but not less important note, we show an alternative method to define a limits file; it is possible to input the frequency mask as a text file as below.

```

[UPPER LIMIT DATA]
FILE=UPPER.TXT
[LOWER LIMIT DATA]
FILE=LOWER.TXT
  
```

The files 'upper.txt' and 'lower.txt' are export ASCII files that may be produced by other applications or CLIO itself.

The 'upper.txt' file may look like:

Freq[Hz]	dBV
100	5
500	3
5000	1
10000	5

19.6.1 ABSOLUTE VS. RELATIVE FREQUENCY LIMITS

The following limits file defines an **absolute** frequency limit.

```
[ABSOLUTE]
[UPPER LIMIT DATA]
200          100
300          97
10000       97
15000       100
[LOWER LIMIT DATA]
200          82
300          85
10000       85
15000       82
```

The frequency mask is shown in Fig.19.29.

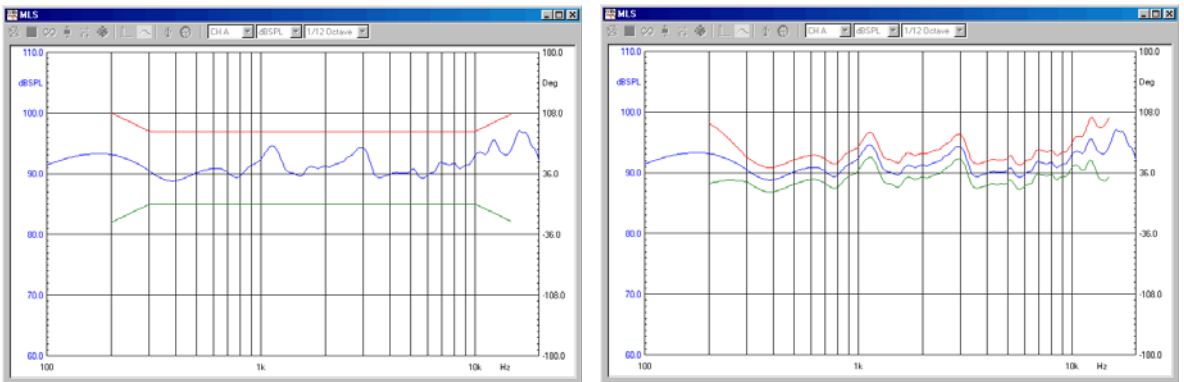

Figure 19.29 and 19.30

The following limits file defines a **relative** frequency limit.

```
[RELATIVE]
[UPPER LIMIT DATA]
200          5
300          2
10000       2
15000       5
[LOWER LIMIT DATA]
200         -5
300         -2
10000      -2
15000      -5
```

The frequency mask is shown in Fig.19.30. **Relative means with respect to the reference file defined in the QC test.** Data values will be added and subtracted to the reference value at the specified frequencies.

Relative data values may be considered as **percentages**. The following keywords is required.

```
[RELATIVE]
PERCENT=1
```

The above mask may be defined for an impedance measurement curve and considered

as percentage; in this assumption it the calculated limits curves would differ by $\pm 2\%$ in the 300-10000Hz region while $\pm 5\%$ outside with respect to the reference.

An important feature for a relative file is the possibility of adding a **frequency jitter** to the calculated limits curves. This quantity is expressed in fractions of octaves and tells how much jittering is applied to the limits. The effect, shown in the below curves is to allow rapidly changing (but small) frequency behaviours of the measured curves while not loosening too much the mask.

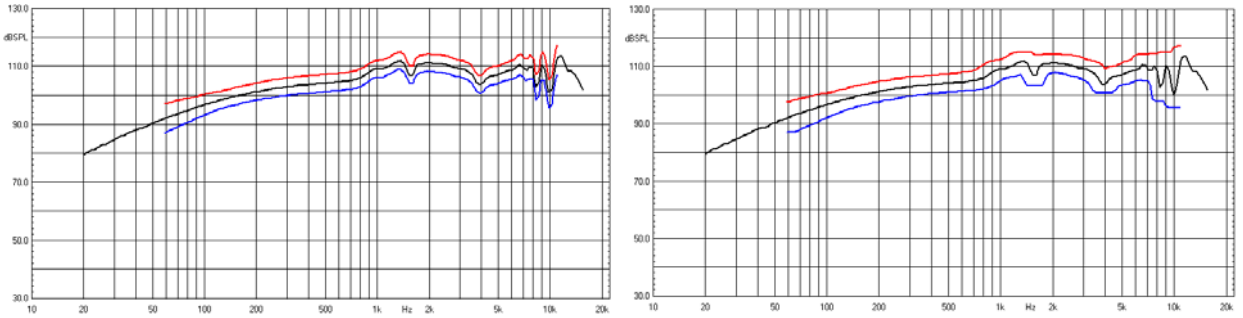

The limit curves in the left figures have no jitter but may be problematic during QC operation, easily giving false negatives, due to the break-up effects in the higher part of the spectrum.

Adding a 1/3 of octave jittering with:

```
[RELATIVE]  
FREQJITTER=0.3
```

You obtain the relative limits as in the right figure which cure the problem not giving rise to false negatives while keeping the mask tight.

It is possible to input up to 2048 frequency points to define the check mask. The QC processor will execute the check starting from the first frequency point, ending at the last; no check will be done outside this frequency range.

Inside a frequency limits file it is possible also to define frequency masks for executing a QC check on the following:

- Average (or single frequency) level (19.6.2 and 19.6.3)
- Sensitivity (average or up to eight frequencies) (19.6.4)
- A/B difference between channels in a stereo measurement (19.6.6)
- Sinusoidal THD, Single harmonic or Fast-Track Rub&Buzz response (19.6.7)
- T&S parameters (Fs,Qt,Qe,Qm,Cms,Mms,Mmd,Vas,BI,dBSPL,ZMin) (19.6.8)
- Loudness Rating (RLR, SLR, STMR) (19.6.9)

A frequency limit file can be applied to an MLS, Sinusoidal or FFT test. To define a limits file for a Multimeter measurement see later.

19.6.2 AVERAGE LEVEL CHECK

The following limits file defines an **average level check** inside the same relative frequency limit shown before.

```
[RELATIVE]
[LEVEL]
UPPER=3
LOWER=-3
FREQHI=5000
FREQLO=400
[UPPER LIMIT DATA]
200          5
300          2
10000        2
15000        5
[LOWER LIMIT DATA]
200         -5
300         -2
10000       -2
15000       -5
```

When a level check is defined inside a limits file the QC result is actually a combination of two separate checks; one is the frequency behavior of the measurement compared against the frequency mask, the second is a level check which compares the average level of the measured curve with the average level of the reference.

The average level is calculated within the frequency extremes defined by FREQHI and FREQLO as shown in Fig.19.31a.

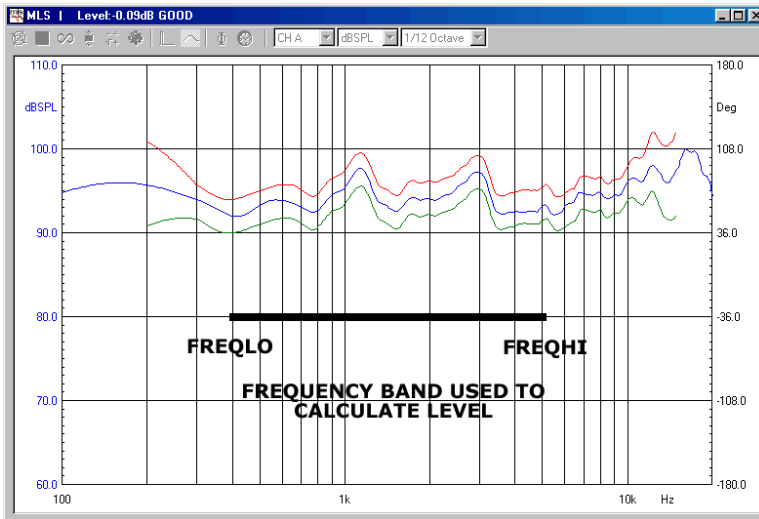

Figure 19.31a

As default, if FREQHI and FREQLO are not defined, the levels are calculated averaging in the frequency band defined by the extremes frequencies of the limits.

Fig.19.31b shows such a situation; the title of the measurement control panel reports the level check.

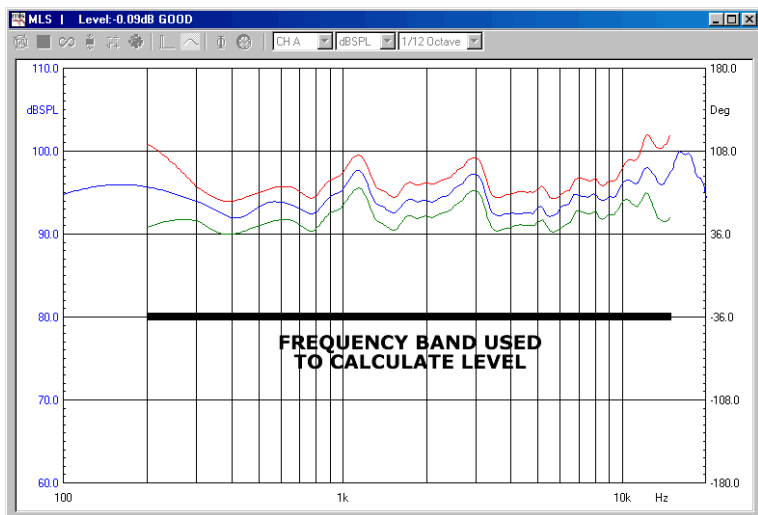

Figure 19.31b

The level check shown means that the value of the measurement averaged in the band shown is 0.09dB higher than the reference average level in the same frequency band.

The measured curve is shifted from this value and then the frequency check is performed (see also 19.6.4).

The level shift means that the curve is displayed with a different level from the measured one. Refer also to Fig. 19.19.

As two separate checks are done there may be two distinct cases when a unit results in a bad report. The following figures try to explain these two cases.

Figure 19.32 shows us the case of a unit is testing bad because the frequency behaviour is not good while the average level is OK.

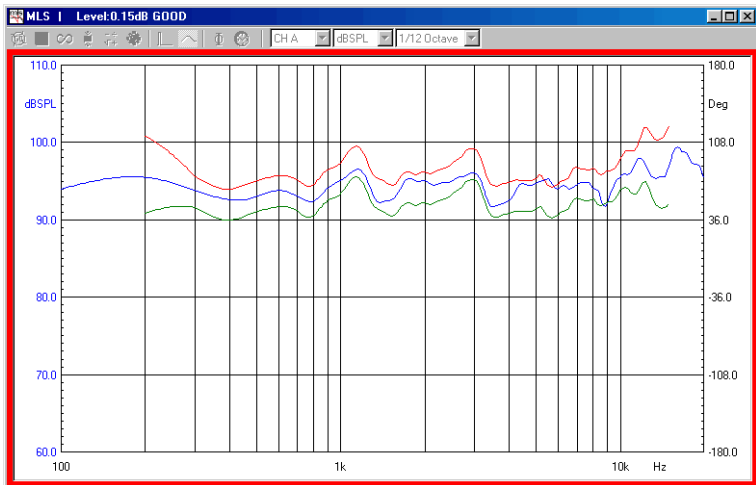
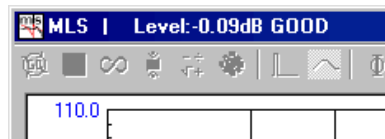

Figure 19.32



Figure 19.33, instead, shows us the case of a unit is testing bad because the average level is not good while the frequency behavior is OK.

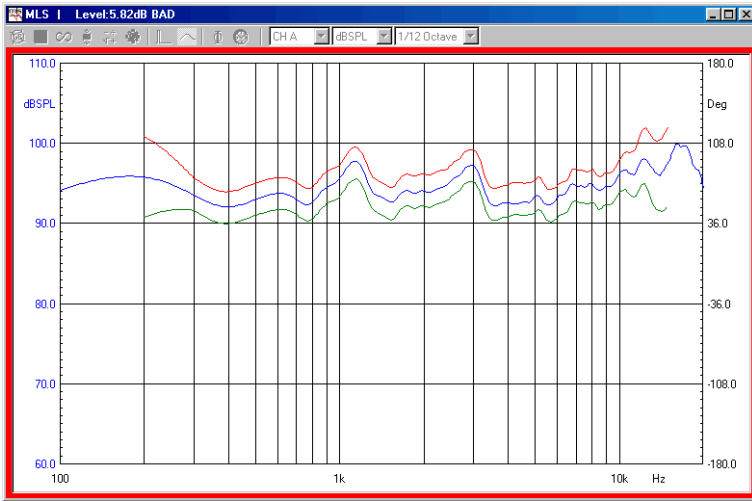

Figure 19.33



19.6.3 ALIGNED MASK

The following limits file defines a **single point level check with a frequency mask aligned to it**.

```
[ABSOLUTE]
[LEVEL]
UPPER=3
LOWER=-3
ALIGNFREQ=5000
ALIGNLEV=90
[UPPER LIMIT DATA]
200          5
300          2
800          2
1000         6
3000         6
4000         2
7000         2
15000        8
[LOWER LIMIT DATA]
200         -5
300         -2
10000       -2
15000       -5
```

The **align point** (in the example 90dB SPL@5000Hz) is used to build the frequency mask (that is specified relative to it) and also to identify the frequency at which to perform the level check.

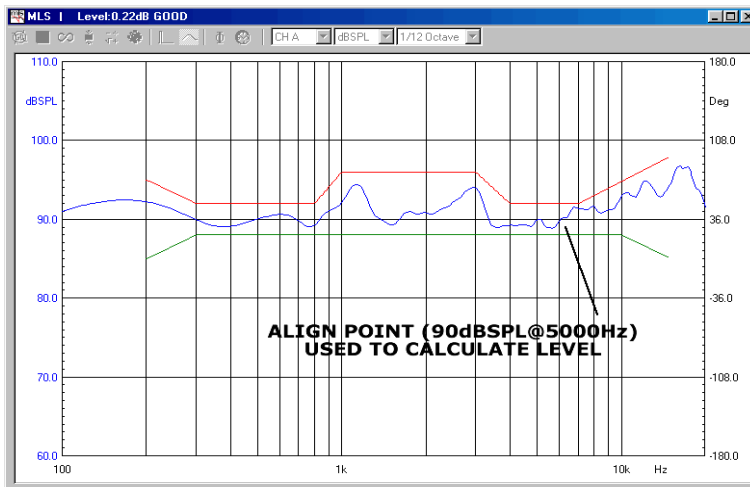

Figure 19.34

Fig.19.34 shows a mask aligned to the point (90dB SPL@5000Hz). The level check means that the value of the measurement at 5000Hz is 0.22dB higher than the align point.

The measured curve is shifted from this value to pass at exactly 90dB SPL at 5000Hz; then the frequency check is performed (see also 19.6.4).

The level shift means that the curve is displayed with a level different from the measured one. Refer also to Fig. 19.19.

19.6.4 SENSITIVITY CHECK

The following limits file defines a **sensitivity check** inside a relative frequency limit.

```
[RELATIVE]
[SENSITIVITY]
UPPER=102
LOWER=100
[UPPER LIMIT DATA]
200      10
500      10
1000     5
1500     5
2000     10
4000     10
[LOWER LIMIT DATA]
200     -10
500     -10
1000    -5
1500    -5
2000    -10
4000    -10
```

As per the average level check, when a sensitivity check is defined inside a limits file the QC result is actually a combination of two separate checks; one is the frequency behavior of the measurement compared against the frequency mask, the second is a sensitivity check which compares the sensitivity of the measured curve with the defined upper and lower limits.

It is possible to calculate sensitivity at discrete frequencies (up to eight) and average them together.

```
[SENSITIVITY]
FREQ1=500
FREQ2=1000
FREQ3=2000
UPPER=102
LOWER=100
```

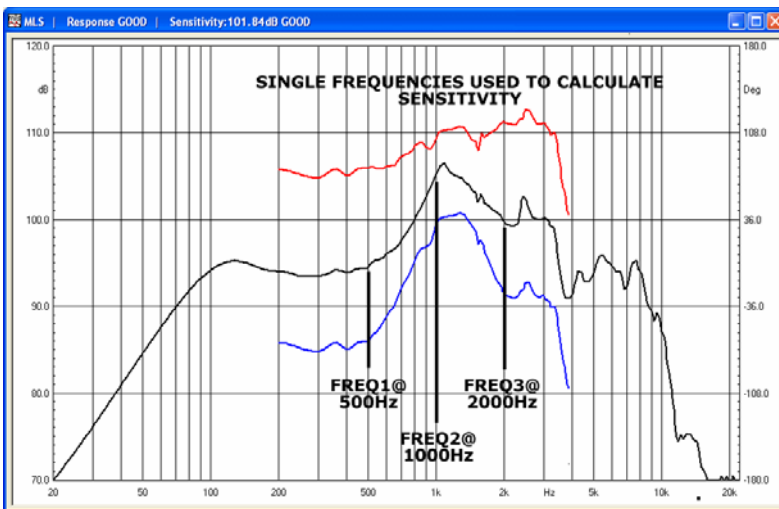

19.6.5 FLOATING LIMITS VS. FLOATING CURVES

When an average or single frequency level check is defined (19.6.2 or 19.6.3) it is possible to define floating limits instead of floating curves using the [FLOATING] keyword.

```
[RELATIVE]
[FLOATING]
[LEVEL]
UPPER=3
LOWER=-3
[UPPER LIMIT DATA]
200          5
300          2
10000       2
15000       5
[LOWER LIMIT DATA]
200         -5
300         -2
10000      -2
15000      -5
```

In this case the measured curve is presented on screen with correct values while the limits curves are moved around it.

19.6.6 SINUSOIDAL A/B STEREO DIFFERENCE CHECK

When executing a stereo sinusoidal frequency response measurement it is possible to activate quality control checks over the calculated difference between the two channels.

The **display** is possible only for one curve chosen among the pool of the curves calculated within a single sinusoidal test (see 19.6.7).

Note: When a distortion curve is displayed, its graphical properties are defined within CLIO Otpions>Graphics>" QC Curve C" .

For **A/B stereo difference** QC check do the following:

- 1) Execute and save a stereo reference measurement.
- 2) Define a limits file adding the limit definition:

```
[A/B UPPER LIMIT DATA]
```

```
[A/B LOWER LIMIT DATA]
```

Select A/B calculated curve for display:

```
[A/B DISPLAY]
```

19.6.7 SINUSOIDAL THD AND FAST-TRACK RUB&BUZZ CHECK

When executing sinusoidal frequency response measurements it is possible to activate quality control checks over calculated THD, Rub-&Buzz or single harmonic (from 2nd to 10th) response curves.

Calculation and QC check is possible for any distortion curve.

The **display** is possible only for one curve chosen among the pool of the curves calculated within a single sinusoidal test (see 19.6.6).

Note: When a distortion curve is displayed, its graphical properties are defined within CLIO Otpions>Graphics>" QC Curve C" .

For **THD and Harmonics** QC check do the following:

- 1) Execute and save a reference measurement with "THD Enabled" under settings.
- 2) Define a limits file adding the limit definition:

```
[THD UPPER LIMIT DATA]
```

for THD and for any harmonic (if desired):

```
[2 UPPER LIMIT DATA]
```

```
[3 UPPER LIMIT DATA]
```

```
..
```

```
..
```

```
[10 UPPER LIMIT DATA]
```

Select one calculated curve for display:

```
[THD DISPLAY]
```

For **Fast-Track Rub&Buzz** QC check do the following:

- 1) Execute and save a reference measurement with "R&B Enabled" under settings.
- 2) Define a limits file adding the limit definition:

```
[RUB+BUZZ UPPER LIMIT DATA]
```

Select rub&buzz curve for display:

```
[RUB+BUZZ DISPLAY]
```

NOTE 1: If more than one curve is selected for display only one will be displayed, the others only calculated and QC check done; to inspect the curves not displayed after a QC test is finished you must release the measurement (see 19.4.1) and operate the proper buttons within the sinusoidal menu.

NOTE 2: If a level or sensitivity check is performed within the QC check and the distortion data are expressed in dB units (not % units) the calculated limit masks (R&B, THD and nth Harmonic) will be shifted to take into account the sensitivity difference with the reference.

19.6.8 THIELE&SMALL PARAMETERS CHECK

It is possible to execute QC tests of the following T&S parameters:

Qt, Qe, Qm, Fs, Cms, Mms, Mmd, BI, Vas, dBSPL and ZMin.

To evaluate the first four parameters it is necessary to input the value of the DC resistance of the voice coil with the keyword **REDC**.

To evaluate the remaining parameters, by means of a simplified estimation routine, it is necessary to input the value of the driver diameter with the keyword **DIAMETER** and one of the following fixed quantities: **KNOWNMMD** (fixed mass) or **KNOWNMMS** (fixed mass plus air load) or **KNOWNCMS** (fixed compliance).

The following limits file defines a T&S parameters check inside a limits file with a frequency mask for an impedance response. The parameters checked are **Qt, Qe, Qm** and **Fs**.

```
[TSPARAMETERS]
QTUPPER=0.3
QTLLOWER=0.05
QEUPPER=0.3
QELLOWER=0.05
QMUPPER=5
QMLLOWER=2
FSUPPER=90
FSLLOWER=50
REDC=5.5
[UPPER LIMIT DATA]
29.89          142.35
40.52          161.19
102.15         161.19
152.62         143.53
[LOWER LIMIT DATA]
29.89          11.29
49.23          20.00
64.33          45.88
76.28          47.06
98.49          22.35
141.87         11.76
```

The following section defines a T&S check of **Qts, Fs, Cms, BI** and **ZMin** having fixed the mechanical mass **Mmd** value.

```
[TSPARAMETERS]
REDC=6.2
DIAMETER=110
KNOWNMMD=10.7952
QTSUPPER=0.6
QTSLOWER=0.3
FSUPPER=90
FSLLOWER=50
CMSUPPER=1.1
CMSLOWER=0.8
BLUPPER=6.5
BLLLOWER=6
ZMINUPPER=7.5
ZMINLOWER=7
```

19.6.9 LOUDNESS RATING CALCULATION AND CHECK

It is possible to execute QC tests of the following loudness rating indicators:

RLR, SLR, STMR.

The following limits file defines a loudness rating parameters check inside a limits file with a frequency mask for an frequency response.

```
[LR]
SLRUPPER=11
SLRLOWER=5
[UPPER LIMIT DATA]
100      3
200     1.5
3000    1.5
5000     3
[LOWER LIMIT DATA]
100     -3
200    -1.5
3000   -1.5
5000    -3
```

19.6.9 MULTIMETER LIMITS FILES

The following limits file defines a multimeter QC check.

```
[UPPER LIMIT DATA]
VOLTAGE=0.78
THD=0.01
[LOWER LIMIT DATA]
VOLTAGE=0.77
THD=0.0001
```

The parameters available are:

- PRESSURE
- VOLTAGE
- FREQUENCY
- THD
- IMD

19.7 MANAGING PRODUCTION BATCHES

Managing a production batch is a rather complex while delicate topic as it involves diverse needs of diverse areas inside your company.

CLIO QC handles your batch doing the following:

- Maintains a directory structure where different files are saved
- Automatically saves production report files
- If requested autosaves data files
- Handles 24 characters alphanumeric serial numbers
- Auto increments serial number and maintains its coherence
- Calculates statistical data about the batch

The result is that you will find the production well documented both for your internal purposes aimed to achieve the highest quality standard and also for interfacing with your client who requests technical information about the units.

19.7.1 DIRECTORIES CREATED BY CLIO QC

Suppose you saved your script inside the directory 'My qc'. When you run the script CLIO automatically creates one or more directories under 'My qc'. There are four cases depending on the option you set:

- 1) No Autosave is active. A Batch is not defined.
CLIO creates the 'Report' directory where all the production report files are saved. Fig.19.37 shows this situation.
- 2) Autosave is active. A SaveFolder is not defined. A Batch is not defined. C L I O creates the 'Report' directory where all the production report files are saved. It also creates the 'Autosave' directory where all data files are saved. Fig.19.38 shows this situation.

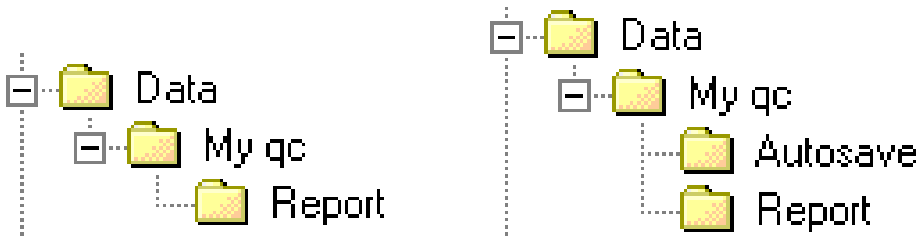

Figure 19.37 and 19.38

- 3) A Batch is defined and is named 'My Batch'. A SaveFolder is not defined.
CLIO creates the 'My Batch' directory where all the production report and also data files are saved. Fig.19.39 shows this situation.
- 4) A SaveFolder is defined and is named 'My Savefolder'.
CLIO creates the 'My Savefolder' directory where all the production report and also data files are saved. Fig.19.40 shows this situation.

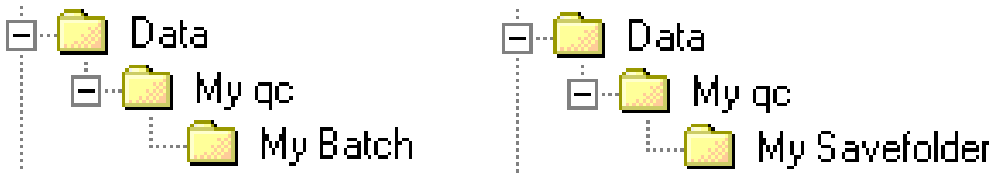

Figure 19.39 and 19.40

19.7.2 PRODUCTION REPORT FILES

Suppose that today, June 6, 2002, at 6:46, you started a production of your devices; the batch, named 'My Batch', ended yesterday with unit number 100.

After two units tested CLIO will add, under the folder 'My Batch', the following report files:

```
'production_06-06-02_6.46.19.txt'  
'101.txt'  
'102.txt'
```

After 20 units tested:

```
'production_06-06-02_6.46.19.txt'  
'101.txt'  
'102.txt'  
.....  
'120.txt'
```

If you stop the production, exit CLIO, and then restart it at 7:01, after two more units tested:

```
'production_06-06-02_6.46.19.txt'  
'production_06-06-02_7.01.05.txt'  
'101.txt'  
'102.txt'  
.....  
'122.txt'
```

The files '**production_date time.txt**' describe the QC session. They look like:

STATISTICS

```
MY COMPANY  
MY QUALITY CONTROL  
BATCH = My Batch  
DATE = 06-06-02  
INITIAL SN = 101  
TOTAL TESTS = 2  
GOOD = 2  
BAD = 0
```

TEST REPORT

```
UNIT N.102 GOOD 6.46.24  
  1  GOOD MLS  
      Response GOOD  
      C:\Program files\Audiomatica\CLIOpci\Data\My qc\My  
Batch\102_1.mls  
  2  GOOD MET  
      Voltage:0.775Vrms GOOD  
      THD:0.006% GOOD  
      C:\Program files\Audiomatica\CLIOpci\Data\My qc\My  
Batch\102_2.met  
UNIT N.101 GOOD 6.46.19  
  1  GOOD MLS  
      Response GOOD  
      C:\Program files\Audiomatica\CLIOpci\Data\My qc\My
```



```
Batch\101_1.mls
    2    GOOD MET
        Voltage:0.775Vrms GOOD
        THD:0.006% GOOD
        C:\Program files\Audiomatica\CLIOpci\Data\My qc\My
Batch\101_2.met
```

The files '**serialnumber.txt**' describes the single QC test and look like this:

```
1 GOOD MLS
    Response GOOD
2 GOOD MET
    Voltage:0.775Vrms GOOD
    THD:0.006% GOOD
06-06-02 6.46.24
UNIT N. 102 GOOD
```

19.7.3 AUTOSAVED DATA FILES

Again supposing we are in the situation of the preceding paragraph let's see how data files are saved. As it can be seen from the report files our QC test consists of a MLS and a Multimeter measurement. As the MLS test is defined **before** the Multimeter inside the script then it assumes number 1 as single QC test while the Multimeter test assumes number 2; this is already clear from the report files above.

After two units tested we find the following measurement files:

```
'101_1.mls'
'101_2.met'
'102_1.mls'
'102_2.met'
```

As you see the QC **single test numbering** is integral part of the name of the autosaved data file.

19.7.4 STATISTICAL INFORMATION ON MEASURED DATA

Statistical information characterizing the production can be obtained by CLIO using the STATISTICS keyword under [GLOBALS].

CLIO will save, under the report directory, the following files:

- One file named '**data_table.txt**' with statistical information on all the measured parameters.
- One file named '**avg_testnumber.txt**' for each response test defined containing the average response for that test.
- One file named '**sdmax_testnumber.txt**' for each response test defined containing the average response plus twice the standard deviation for that test.
- One file named '**sdmin_testnumber.txt**' for each response test defined containing the average response minus twice the standard deviation for that test.

The statistical files keep track of the all the units saved within a batch even if the production is stopped and then restarted.

Let's now see what the 'data_table.txt' looks like; supposing the same case of 19.7.2, after two tests, we would have the following:

```
SN Voltage THD
101 0.775 0.006
102 0.775 0.006

Avg 0.775 0.006
SDMax 0.776 0.006
SDMin 0.775 0.006
```

The other response files representing average and standard deviation curves may be imported within each control panel with the Import feature recallable with **Shift-F3**.

19.7.5 SERIAL NUMBER MANAGEMENT

There are several ways to handle the serial numbers of your devices and to maintain their coherence through all the production of one batch.

Two different strategies are possible with respect to serial number management:
1 - CLIO handles and manages an **8-digit numeric** serial number. This is the default operation.

2 - CLIO accepts a **24 characters alphanumeric** serial number; its management is left to the user.

To activate the second option use the AUTOSN=0 keyword (default is AUTOSN=1).

```
[GLOBALS]
...
AUTOSN=0
...
...
[SNINPUT]
```

The operator is prompted for serial number input using the [SNINPUT] keyword. Input can be done with any kind of bar code reader.

It is also possible to manually input the serial number before starting the test; to do this just click on the **S_N** button.

Under default operation (AUTOSN=1) the 8-digit serial number is automatically increased after the end of the test. It is possible to avoid a bad unit increasing the serial number using the INCREASEONBAD=0 keyword.

Set INCREASEONBAD=0 if you want only good units to have a serial number, report , statistical and autosave management; this works also when AUTOSN=0.

The operator, under her or his judgment, can force the final result of a bad test if the keyword PROMPTFORGOOD=1 is used.

19.7.6 THE SKIP LAST BUTTON

When a QC test is finished it is also possible to null its result by pressing the Skip Last  button. All information saved with the test will be erased comprising serial number increment and statistical data. The production report will mark the unit as 'SKIPPED'.

19.8 INTERACTING WITH EXTERNAL HARDWARE

The interaction with external hardware gives CLIO the possibility of realizing semi or fully automatic production line QC tests. Several keywords have been introduced to implement this functionality (see to reference section for a complete listing).

19.8.1 INPUT SENSITIVITY AND OUTPUT VOLTAGE CONTROL

As we have already seen it is of fundamental importance to correctly set CLIO's input sensitivity and output level (see 4.5). The IN and OUT keywords are used for this. The script below sets the input sensitivity at 10dBV and output level at 0dBu. These numbers also directly appear also in the main tool bar of CLIO.

```
...
IN=10
OUT=0
...
```

The OUTUNITS keyword can be used, under [GLOBALS], to define the output level unit of measure; you may choose either V, dBV or dBu; default is dBu. To output 1V simply write:

```
[GLOBALS]
OUTUNITS=V
...
OUT=1
...
```

or, even simpler,

```
...
OUT=1V
...
```

If you feed the output to a power amplifier the resulting signal at amplifier terminals will be amplified by the gain of the amplifier. It is possible to take this effect into account and specify the output level directly at the amplifier's output in the particular case you are using a CLIOQC Amplifier & SwitchBox. The following script can be used to set 2.83V at the output of the amplifier.

```
...
OUTQCBOX=2.83V
...
```

19.8.2 QCBOX MODEL 5 DC OUTPUT CONTROL

The QCBox Model 5 Amplifier&SwitchBox has the capability of superimposing a DC voltage to the generated signal. It is possible to manage this DC voltage with the QCBOXDCOUT keyword. This DC voltage ranges from -20 to 20V. The script below sets a 2V DC at speakers terminals.

```
[PERFORM]
QCBOXDCOUT=2
```

19.8.3 CLIOQC AMPLIFIER&SWITCHBOX CONTROL

Using a CLIOQC amplifier & switchbox it is possible to setup a powerful QC environment like the ones described in chapter 20.

Custom keywords have been implemented to easily control all the internal functions of this unit:

[SETINPUT1] Selects input 1 of the CLIOQC Amplifier & SwitchBox.

[SETINPUT2] Selects input 2 of the CLIOQC Amplifier & SwitchBox.

[SETINPUT3] Selects input 3 of the CLIOQC Amplifier & SwitchBox.

[SETINPUT4] Selects input 4 of the CLIOQC Amplifier & SwitchBox.

[SETINPUT5] Selects input 5 of the CLIOQC Amplifier & SwitchBox.

[SETINPUT6] Selects input 6 of the CLIOQC Amplifier & SwitchBox.

[SETINPUT7] Selects input 7 of the CLIOQC Amplifier & SwitchBox.

[SETINPUT8] Selects input 8 of the CLIOQC Amplifier & SwitchBox.

[SETIMPEDANCE] Selects impedance mode of the CLIOQC Amplifier & SwitchBox.

[SETISENSE] Selects I Sense mode of the CLIOQC Ampli&SwitchBox.

Specific keywords are dedicated to the **QCBox Model 5**; these keywords have no effect in the case of earlier versions of the unit.

QCBOXCURRENTLIMIT

Current limit (A) for Model 5 operation. Ranges from 0 to 10.

QCBOXDCOUT

DC voltage (V) to be output by Model 5 superimposed to generated signal. Ranges from -20 to 20.

QCBOXINITIALBYTE

8-BIT binary value that will be output from Model 5 port at startup before QC script execution.

QCBOXOUTBIT0

Status (=1 or =0) of the bit that will be output from Model 5 BIT0.

QCBOXOUTBIT1

Status (=1 or =0) of the bit that will be output from Model 5 BIT1.

QCBOXOUTBIT2

Status (=1 or =0) of the bit that will be output from Model 5 BIT2.

QCBOXOUTBIT3

Status (=1 or =0) of the bit that will be output from Model 5 BIT3.

QCBOXOUTBIT4

Status (=1 or =0) of the bit that will be output from Model 5 BIT4.

QCBOXOUTBIT5

Status (=1 or =0) of the bit that will be output from Model 5 BIT5.

QCBOXOUTBYTE

8-BIT binary value that will be output from Model 5 port.

QCBOXPHANTOM

Microphone power supply voltage (V) set for Model 5 IN1 and IN2 input. Ranges from 2 to 24.

19.8.4 EXTERNAL TRIGGER

It is possible to trigger the QC tests sequence with the following:

- 1) A foot pedal switch connected to QCBox Pedal In connector.
- 2) The connection of the loudspeaker under test sensed by QCBox Model 5.
- 3) An external TTL signal wired to one of the QCBox Model 5 input.
- 4) An external TTL signal wired to the PC parallel printer port.

The settings are within CLIO Options>QC (See 19.4.8).

This operation is controlled by the External Trigger button in the QC control panel and by the **MANUAL** keyword inside the QC script.

Fig.19.41 shows a foot pedal switch and shows its connection to the PC to enable the control of the QC test.

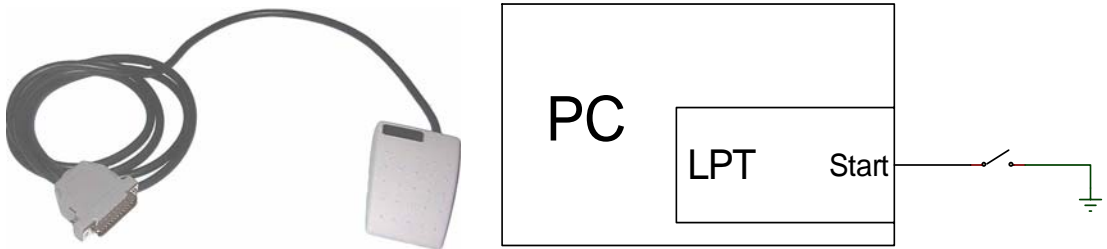

Figure 19.41

The QCBox Model4 and Model 5 have a dedicated input 'PEDAL IN' that can be used to connect the external foot pedal or trigger signal.



The following lines are needed inside a script file to enable a switch (or externally generated TTL signal) to start and continue a QC measurement.

```
[GLOBALS]
...
...
MANUAL=0
```

Please refer to 19.8.7, 19.8.8 and to the commands reference for more details on TTL input signal management.

19.8.5 TTL SIGNALS GENERATION

CLIO QC has powerful capabilities to generate and read TTL control signal to be able to interface with an external line automation.

To manage these TTL signals it is possible to use:

- 1) The parallel port of the computer, if present.
- 2) The dedicated Digital I/O port of the QCBox Model 5 (USB controlled).

It is possible to define the status of the bits of the digital port involved; the following is a list of the kind of signals possible:

- signals output at startup (INITIALBITS, QCBOXINITIALBYTE)
- signals conditioned by the result of a single measure ([IF LAST GOOD], [IF LAST BAD])
- signals conditioned by the global result ([IF ALL GOOD], [IF ALL BAD])
- unconditioned signals ([PERFORM])

Let's see an example of generation of external signals conditioned by the result of the measurement (LPT Parallel Port case):

```
[GLOBALS]
...
...
INITIALBITS=0
[FFT]
...
...
[MLS]
...
...
[IF LAST BAD]
BIT=3
BITVALUE=1
DELAY=200
[IF LAST GOOD]
BIT=3
BITVALUE=0
DELAY=200
[IF ALL GOOD]
BIT=1
BITVALUE=1
[PERFORM]
BIT=0
BITVALUE=1
DELAY=200
[PERFORM]
8BITVALUE=0
```

This example defines a signal high on bit 3 if the MLS test performs bad, a signal high on bit 1 if all the tests are OK and an unconditioned pulse of 200 ms on bit 0 that may be used to signal the end of the QC test sequence.

Referring to Figure 19.42 we can see the time signal of the three bits in the two possible cases A and B; in case A the MLS test performed bad and in case B good.

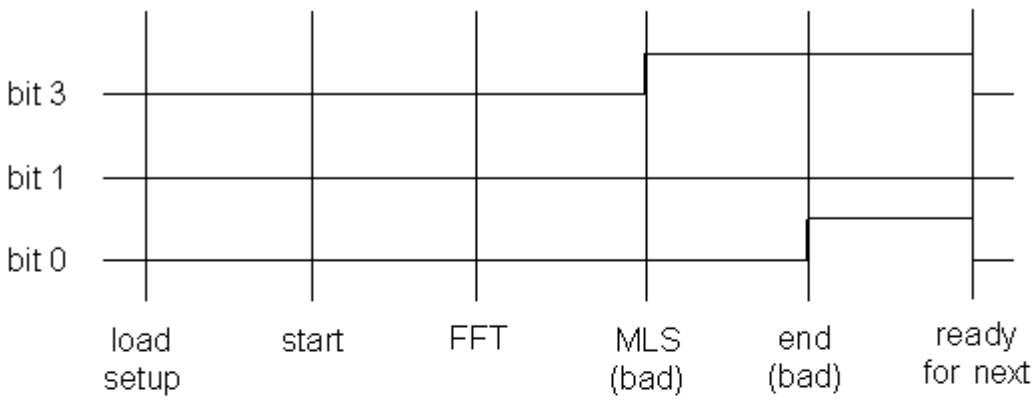

A

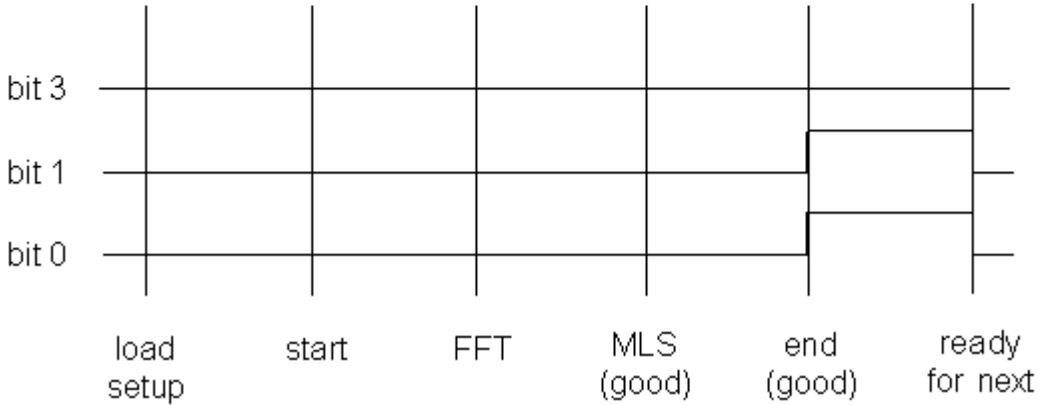

B

Figure 19.42

Let's see now translate the same script with QCBox Model 5 dedicated keywords:

```
[GLOBALS]
...
...
QCBOXINITIALBYTE=0
[FFT]
...
...
[MLS]
...
...
[IF LAST BAD]
QCBOXOUTBIT3=1
DELAY=200
[IF LAST GOOD]
QCBOXOUTBIT3=0
DELAY=200
[IF ALL GOOD]
QCBOXOUTBIT1=1
[PERFORM]
QCBOXOUTBIT0=1
DELAY=200
[PERFORM]
QCBOXOUTBYTE=0
```



19.8.6 TIME DELAYS GENERATION

It is possible to define a time delay in any point of a script file with the following definition:

```
[PERFORM]  
DELAY=200
```

In this example the QC sequence waits for 200 millisecond when encountering these keywords. In the previous paragraph you can also see the possibility of mixing time delays with signals definitions in order to generate pulses.

19.8.7 PARALLEL PORT SIGNALS MANAGEMENT

The TTL signals generated with the active parallel printer port of the PC may be interactively controlled by means of the QCBox&LPT menu recallable with **Shift-F4**. After opening this box press the Direct TTL Control button  and you obtain the control panel shown in figure. To get TTL signals operation please select a parallel port from the ones available.

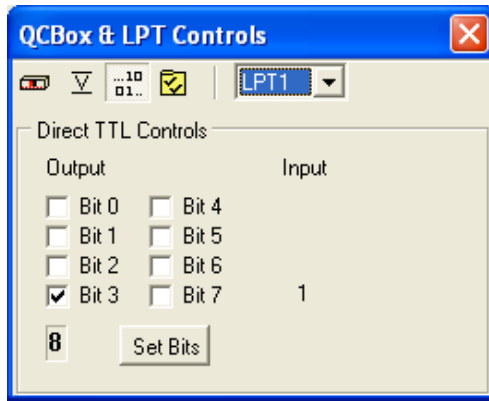

The Direct TTL Controls dialog lets you set the status of the eight output bits using the appropriate check boxes while triggering it with the Set Bits button; a decimal representation of the output binary word is also present. On the left side the status of the input start bit is reported.

The pin-out of the standard parallel port is shown below; note the eight output bits and the start trigger pulse in input.

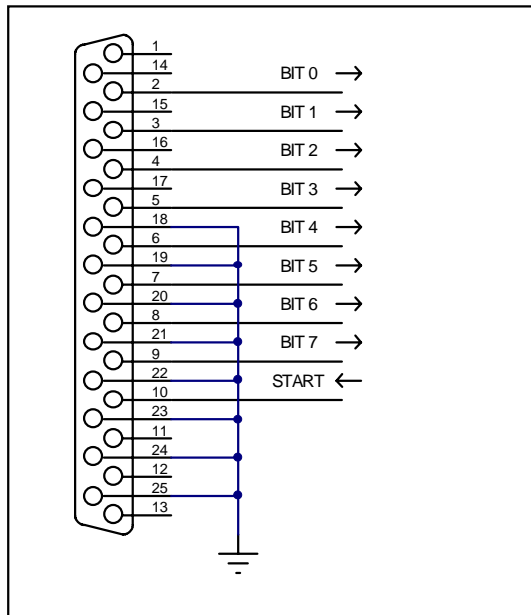

19.8.8 QCBOX MODEL 5 DIGITAL I/O SIGNALS MANAGEMENT

Using the QCBox Model 5 Digital I/O port it is possible to generate/monitor TTL signals to be used for interfacing along production lines; these key features are controlled over the USB connection of the Model 5 so there is no need for legacy devices like LPT ports.

The TTL signals generated with the QCBox Model 5 may be interactively controlled by means of the QCBox&LPT dialog recallable with **Shift-F4**. After opening this box press the Model 5 button  and you obtain the control panel shown in figure.

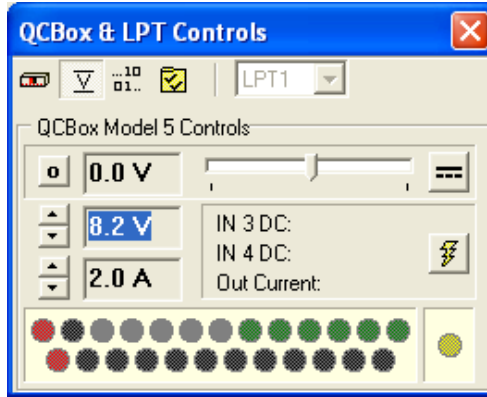

The Model 5 Controls dialog lets you interactively set the status of the output bits while monitoring the input ones; simply click on green pin to control its status.

The pin-out of the Digital I/O port of the QCBox Model 5 is shown in figure; note the six output bits, the four input bits and the +5V line.

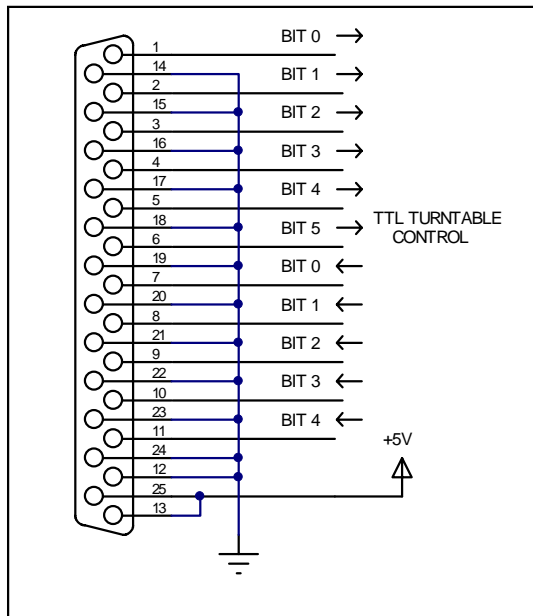

19.8.9 RS-232 SERIAL PORT CONTROL

During QC execution it is possible to control serial devices, like label printers, connected via an RS-232 link to your PC. You can select and configure a COM port for QC control within CLIO Options>QC (See 19.4.8).

The following script can be used to print a label at the end of a QC test if the result of the test is good; the printing commands refer to a Zebra Z4M printer.

```
[GLOBALS]
OPENSERIAL=1
SERIALMONITOR=1
...
...
...
...
...
[IF ALL GOOD]
SERIALOUT=^XA^LH40,100,^F020,10^AD^FD@SERIALNUMBER^FS^XZ
```

Note the @SERIALNUMBER acronym that is used to output the current serial number. It is possible to activate, mainly for debugging purposes, a monitor window that echoes RS-232 activity; to do this use the SERIALMONITOR keyword.

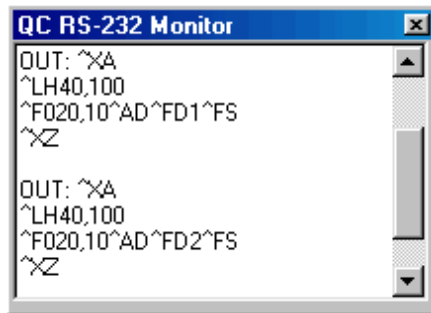

The same text output in the above example could be saved in an ASCII file and loaded with the SERIALOUTFILE keyword:

```
...
...
[IF ALL GOOD]
SERIALOUTFILE=SERIAL.TXT
```

20 QC BY EXAMPLES, TCP-IP MEASUREMENT SERVER AND SYNTAX REFERENCE

20.1 A COMPLETE, FAST, SINGLE-TEST LOUDSPEAKER QUALITY CONTROL

CLIO QC is able to program and execute a very fast, accurate and complete, single-test quality control of a loudspeaker using the new functionality of the sinusoidal measurement menu.

One of the key features of this approach is represented by the new FAST-TRACK™ rub&buzz detection that is carried out along the sinusoidal sweep.

With just one sinusoidal sweep it is possible to measure:

- Frequency response
- Impedance response
- Sensitivity
- Polarity
- Total harmonic distortion response
- Single harmonic response (from 2nd to 10th)
- Rub&Buzz
- T&S parameters ($F_s, Q_t, Q_e, Q_m, C_{ms}, M_{ms}, M_{md}, V_{as}, B_l, dB_{SPL}, Z_{Min}$)

Choosing among the various settings of the sinusoidal test it is possible to tailor the QC test easily, controlling the trade-offs between speed and accuracy.

This example describes a test setup and the relative QC script that may be implemented in an automatic production line capable of cycle times of 1 to 2 seconds with a sweep time of around 1s.

20.1.1 HARDWARE REQUIRED

The following parts of the CLIO system are needed to achieve this kind of QC test:

- CLIO FW-01
- QCBox Model 5
- Microphone (MIC-01,02 or 03)
- Optional 19"rack QC panel

The CLIO system hardware presents itself as in this picture:



The basic connections required are listed here:

- 1) On the electro-acoustic side we find the QCBox used as power amplifier, microphone directly connected to CLIO, current sensing to channel B input to measure impedance.
- 2) On the digital side we find the connection with an external automation that gives a TTL start signal to the QC test and is informed by three output bits of its current status.

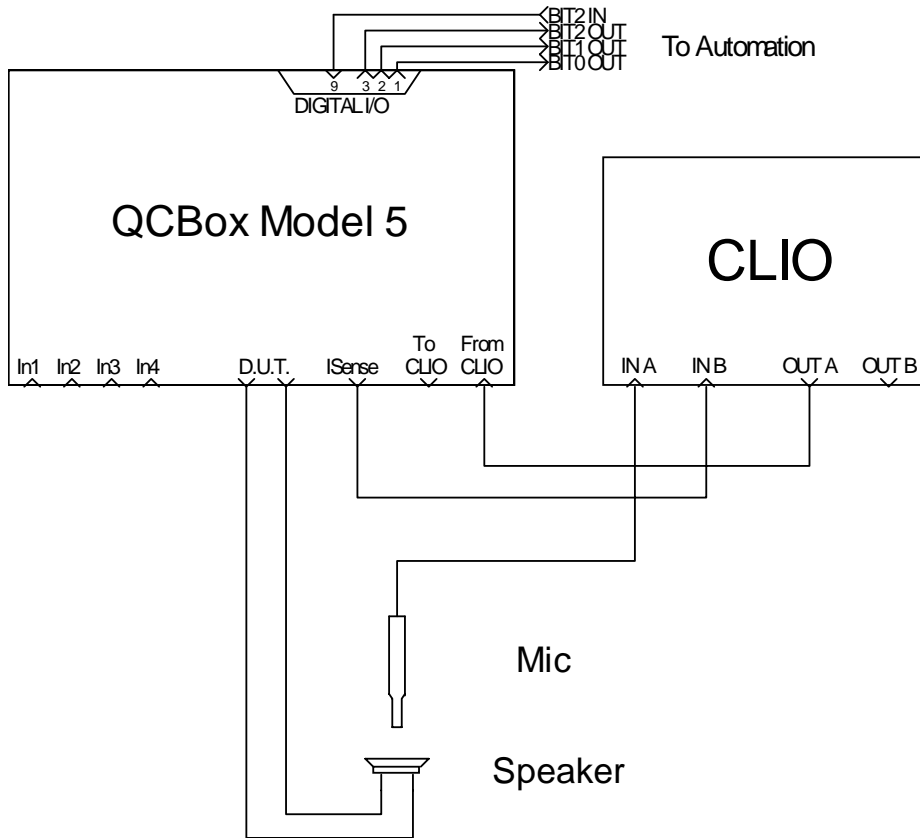

3) On the loudspeaker under test side a suitable acoustic test fixture should be setup to properly isolate from the outside environment. The example is not dealing with this topic.

To properly control the QCBox Model 5 verify its settings within the QCBox&LPT Controls dialog; default settings (i.e. 2A output current limiting) should be OK for many DUTs.

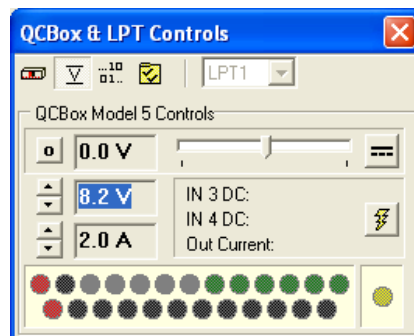
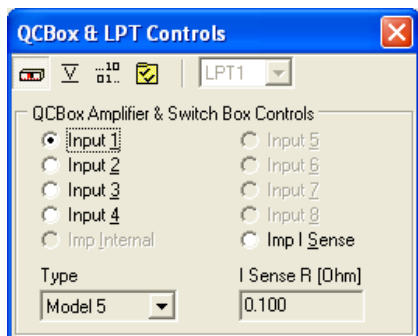

We will deal later with QCBox settings for connecting with the automation.

Once the hardware connections are firmly setup take a reference loudspeaker representative of the production and put it in place ready to be measured. We suppose to deal with a wideband automotive 4" loudspeaker.

This quality control application relies on a stereo sinusoidal test that simultaneously measures frequency response by means of a microphone connected to input A and impedance sensing load current to input B. It is suggested to divide the initial approach in two separate single channel measurements of the two quantities and finally integrate them into a single stereo one.

20.1.2 MEASURING THE REFERENCE FREQUENCY RESPONSE

Open the sinusoidal menu. Let's start with the acoustic frequency response and set up the required sweep opening the the settings dialog. The main parameters affecting sweep are: frequency range chosen from 30Hz to 15kHz, resolution of 1/12 of octave supposed to be fine and speed that is set to "Fast" as best tradeoff for rub&buzz testing.

Before taking the first reference measurement you still need to set the proper output level (here chosen 1V at speaker terminals) as indicated by DUT specifications and accordingly set input sensitivity of CLIO input A; as the final measurement will be stereo operate separately the two input channel controls releasing the Link Input Controls **A/B** button in the hardware toolbar; initial input A sensitivity is -10dBV (channel B is left to 0dBV).

Now, within the sinusoidal menu, choose CHA input channel selection and dB SPL as Y scale unit. Press go. The first measurement gives you the following result

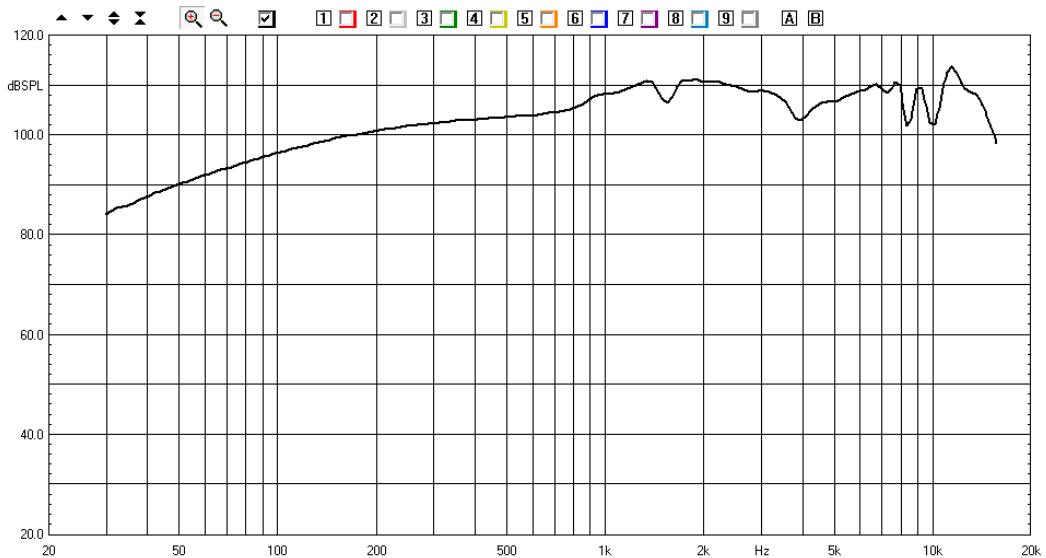

one important parameter now clear is the sweep time that is shown in the sinusoidal menu status bar: with these settings we have 1.05 seconds sweep time. Consider it fine. Save the result to "response.sin" file.

The test should now be tuned up to take into account the acoustic environment and completed with missing settings. Open the sinusoidal settings dialog; proper delay should be set to compensate for microphone distance to loudspeaker, this may be evaluated by the two common ways CLIO gives you i.e. taking a trial sinusoidal measurement with auto delay active or taking a parallel MLS&LogChirp measurement and inspecting the impulse response; in our case we found a 0.2ms delay to be compensated, due to a quasi near field measurement with a microphone to DUT distance, in the acoustic fixture, of circa 7cm. Final settings required are about distortion curves; we need to activate THD and Rub&Buzz calculations clicking on "THD Enabled" and "R&B Enabled", the Rise parameter is set to 0dB as we are going to accommodate all displayed curves inside one single 100dB Y scale graph. Execute the measurement with final frequency response settings.

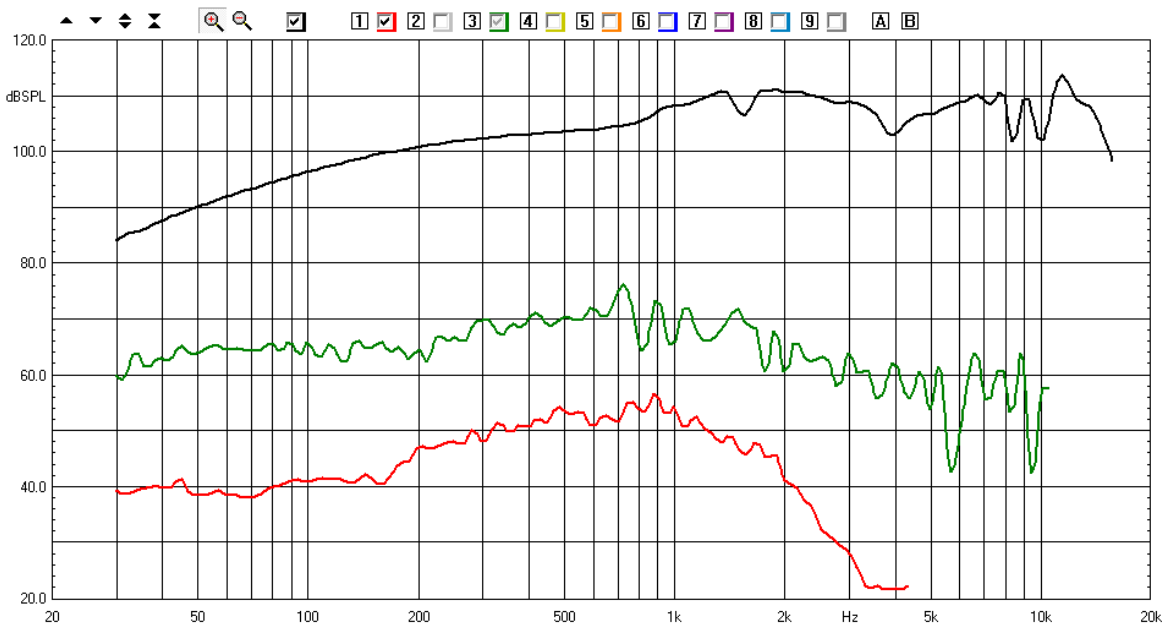

After the measurement is done we may inspect THD and Rub&Buzz pressing the relative buttons, in figure they are shown as overlays (green THD, red R&B). Repeat the measurement until fully confident with the results obtained, eventually refine the settings as needed.

We are now ready to define QC masks for frequency response, THD and Rub&Buzz. Open the QC menu, press the limits button to start defining a limit definition; we require, and manually input, a relative mask to frequency response with the following behaviour:

```
[RELATIVE]
[UPPER LIMIT DATA]
20          10
80          10
100         3
5000        3
6000        5
20000       5
[LOWER LIMIT DATA]
20          -10
80          -10
100         -3
5000        -3
6000        -5
20000       -5
```

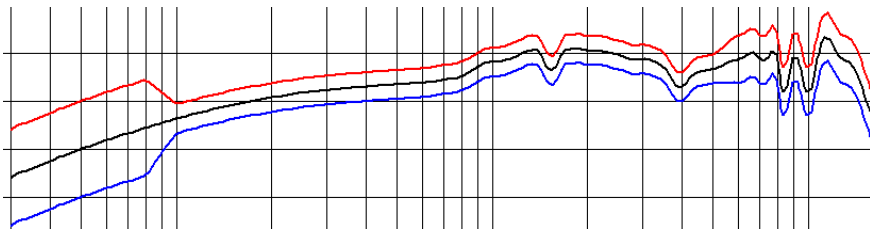

The limits definition for THD and R&B is, for their nature, inherently absolute and only requires an upper curve so we may begin defining them by direct, on-screen, drawing.

Pressing the THD button, inside sinusoidal menu, you obtain the THD curve; inside QC you press the "Draw Limits Controls" button and you are allowed to draw a limit curve directly on the sinusoidal graph; at the end the QC limit definition panel will be filled with data about the drawn limit:

```
[THD UPPER LIMIT DATA]
30.81          69.56
174.96        69.78
639.82        80.62
1603.03       78.19
10869.90      64.25
10869.90      64.25
```

Pressing the R&B button, inside sinusoidal menu, you obtain the R&B curve; inside QC you press the "Draw Limits Controls" button and you are allowed to draw a limit curve directly on the sinusoidal graph; at the end the QC limit definition panel will be filled with data about the drawn limit:

```
[RUB+BUZZ UPPER LIMIT DATA]
30.11          48.32
143.15         48.76
445.16         60.49
1692.02        59.38
3924.35        30.18
```

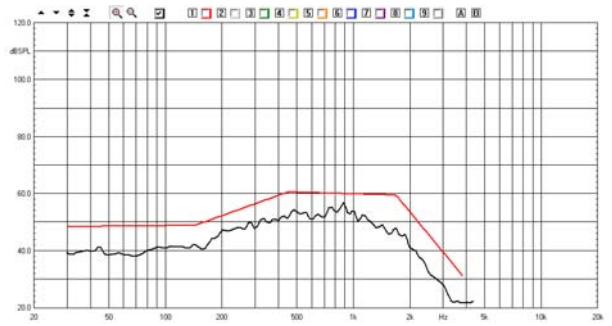
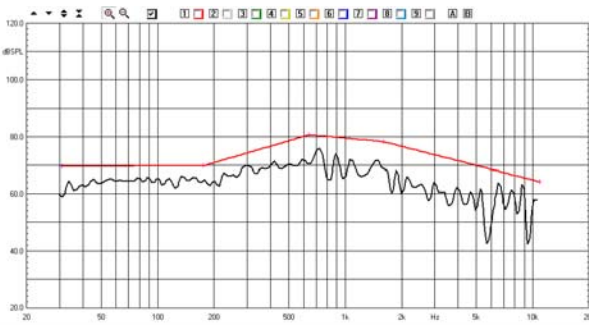

It is time to save the limits file as "response.lim".

As we are dealing with an unsmoothed frequency response that is presenting some high frequency "peaks and dips" we like to give a 1/6 of octave frequency jittering to the calculated limits curve:

```
[RELATIVE]
FREQJITTER=0.16
```

That gives our frequency mask a more comfortable behaviour that is less prone to give false negatives in that troubled spectrum range.

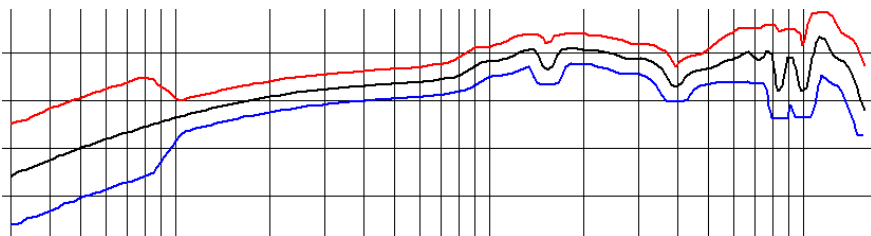

The final parameter that we should take into account is the sensitivity of the loudspeaker; programming a chirp with same frequency extremes and analyzing it with the multimeter we obtain a sensitivity of the reference of 106 dB SPL; this value leads us to complete the limits file definition with sensitivity data.

```
[SENSITIVITY]
UPPER=109
LOWER=103
```

20.1.3 MEASURING THE REFERENCE IMPEDANCE RESPONSE

We put now our attention to the impedance response of our loudspeaker.

Going back to sinusoidal menu we choose CHB with the input channel selector and Ohm as Y Scale unit; inside the sinusoidal settings dialog leave all previous settings unchanged as they will accompany us to the final reference measurement; only change the impedance settings to "QCBox Select" to reflect QCBox operation.

As the output level has already been set for the acoustic test we only have to deal with input sensitivity for channel B; a settings of -30dBV or -40dBV is usually correct for ISense impedance tests. The measurement looks as follow.

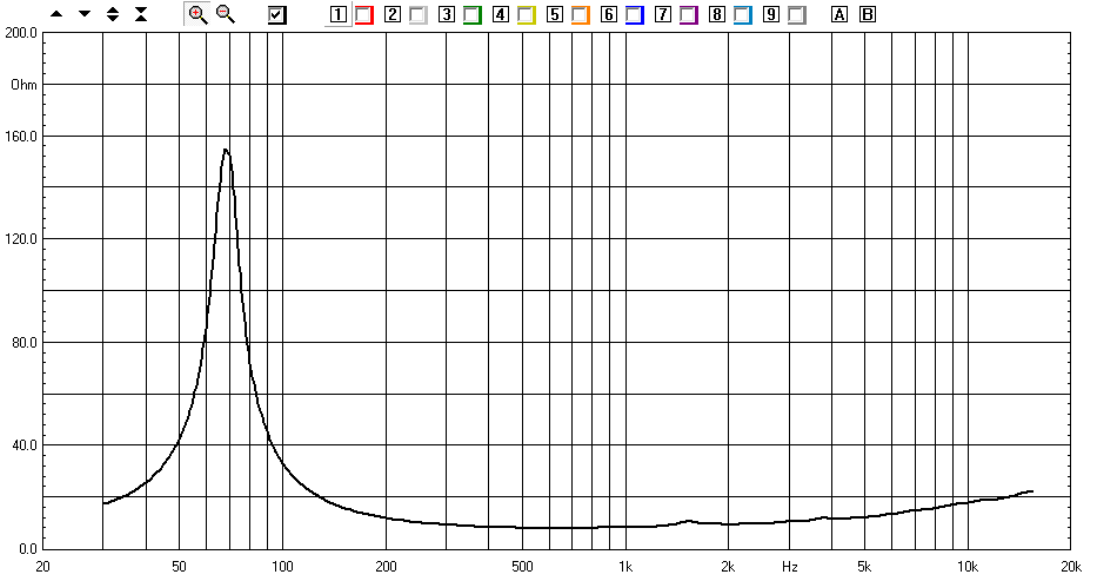

Save the result to "impedance.sin" file.

We are now able to define also the limits file needed to check the impedance response. Going back to the QC menu, inside limits control panel, we should clear information about frequency response masks and be ready for new input.

A response check mask may be defined as follow:

```
[RELATIVE]
PERCENT=1
[UPPER LIMIT DATA]
20          20
50          20
60          30
90          30
100         20
```

```

200          20
1200         20
[LOWER LIMIT DATA]
20          -25
50          -25
60          -30
90          -30
100         -25
200         -25
1200        -25

```

This 20% wide mask spans from below resonance to slightly higher the ZMin region and opens up to 30% in resonance region.

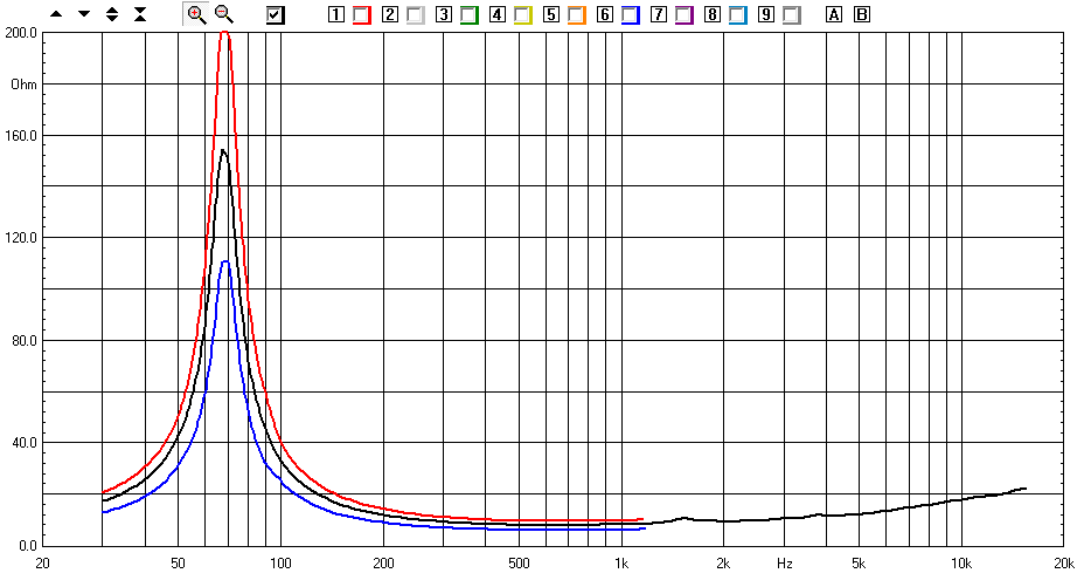

The most important QC checks will be done on T&S parameters that take into account all possible defects from the impedance point of view. In this definition we check F_s , Q_{ms} and Z_{min} to be within 10% from reference.

```

[TSPARAMETERS]
PERCENT=1
DIAMETER=10
REDC=7
KNOWNMMD=5
FSUPPER=10
FSLOWER=-10
QMSUPPER=10
QMSLOWER=-10
ZMINUPPER=10
ZMINLOWER=-10

```

It is time to save the limits file as "impedance.lim".

20.1.4 INTEGRATING THE QC REFERENCE FILE

Starting from the actual situation, i.e. having just measured impedance relying on settings that accumulated from the previous frequency response measurement, we are now ready to integrate all of our work to realize a single stereo sinusoidal measurement that will be the reference for our QC script.

Go to the sinusoidal menu, have the impedance measurement loaded in memory; select CHA&B with the input selector, change the Y Scale unit to dB SPL; CLIO is now ready to take a two channels measurement with main unit set to dB SPL; as the measured unit for channel B needs to be Ohm we must open the sinusoidal settings dialog and select "Ohm Right Scale": **in this way channel B will measure impedance using the right scale to identify it.**

The final sinusoidal settings are:

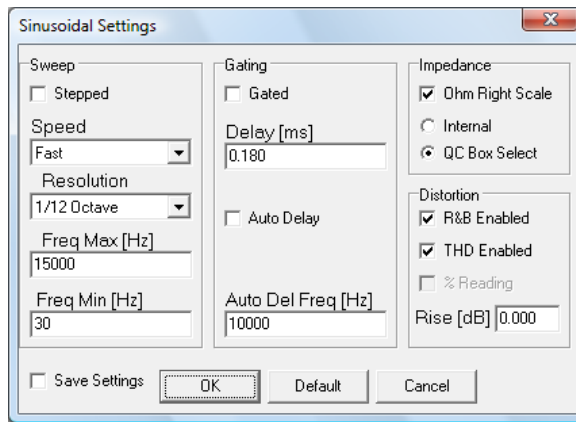

Press Go; the graph obtained has frequency response measured from channel A and refers to left scale while impedance response comes from channel B referring to right scale. Note that the two curves displayed are measured and controlled by dedicated checkboxes, no overlays are active.

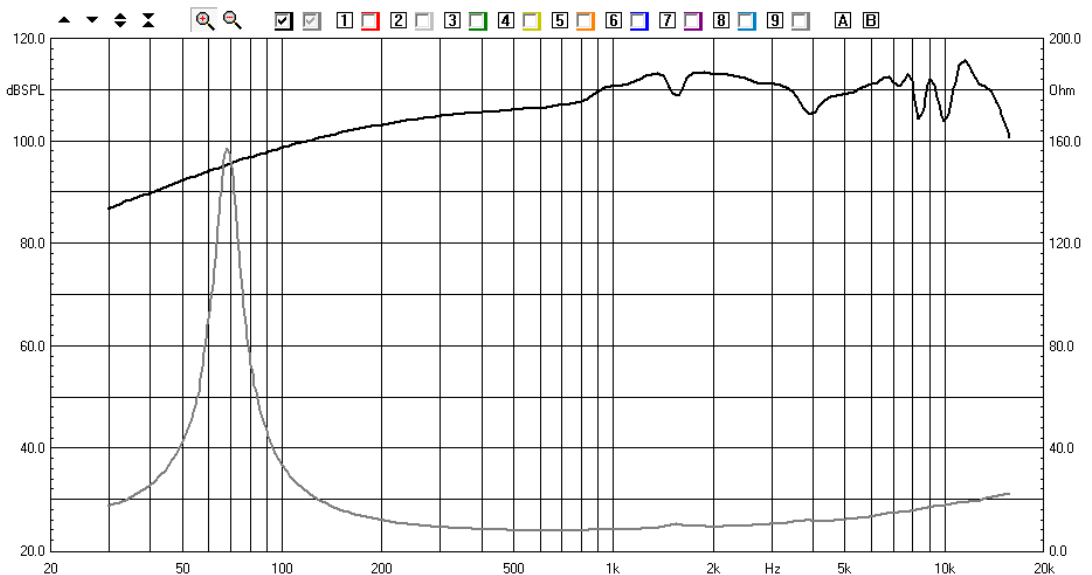

This measurement is OK to be the reference for our QC test; once the frequency scale, Y right and left scales are OK for the visualization under QC it can be saved as "reference.sin". To properly set scales it is useful to directly input values at their extremes; refer to 6.2 and 6.4 for details about this.

20.1.5 PROGRAMMING THE QC SCRIPT

We are ready to write the QC script; the files involved are the stereo sinusoidal measurement stored inside the "reference.sin" file, the limits file for channel A in "response.lim" and the limits file for channel B in "impedance.lim".

```
[SIN]
OUTQCBOX=1V
INA=-10
INB=-40
REFERENCE=REFERENCE.SIN
LIMITSA=RESPONSE.LIM
LIMITSB=IMPEDANCE.LIM
```

Two things are still missing: the polarity check and the visualization of the rub&buzz curve.

1) To add polarity check over the frequency response we simply add POLARITY=1 under [SIN]

2) To add rub&buzz display as a third curve together frequency response and impedance we add [RUB+BUZZ DISPLAY] in the "response.lim" file.

The final script will thus be:

```
[SIN]
OUTQCBOX=1V
INA=-10
INB=-30
REFERENCE=REFERENCE.SIN
LIMITSA=RESPONSE.LIM
LIMITSB=IMPEDANCE.LIM
POLARITY=1
```

This script may now be saved as "faststereosweep.qc".

The final "response.lim" file will be:

```
[RELATIVE]
FREQJITTER=0.16
[SENSITIVITY]
UPPER=109
LOWER=103
[UPPER LIMIT DATA]
20          10
80          10
100         3
5000       3
6000       5
20000      5
[LOWER LIMIT DATA]
20         -10
80         -10
100        -3
5000       -3
```

```

6000          -5
20000        -5
[THD UPPER LIMIT DATA]
30.81        69.56
174.96       69.78
639.82       80.62
1603.03      78.19
10869.90     64.25
10869.90     64.25
[RUB+BUZZ DISPLAY]
[RUB+BUZZ UPPER LIMIT DATA]
30.11        48.32
143.15       48.76
445.16       60.49
1692.02      59.38
3924.35      30.18

```

The final "response.lim" file will be:

```

[RELATIVE]
PERCENT=1
[UPPER LIMIT DATA]
20           20
50           20
60           30
90           30
100          20
200          20
1200         20
[LOWER LIMIT DATA]
20           -25
50           -25
60           -30
90           -30
100          -25
200          -25
1200         -25
[TSPARAMETERS]
PERCENT=1
DIAMETER=10
REDC=7
KNOWNMMD=5
FSUPPER=10
FSLLOWER=-10
QMSUPPER=10
QMSLOWER=-10
ZMINUPPER=10
ZMINLOWER=-10

```

20.1.6 RUNNING THE QC TEST

Running the complete QC test we will obtain a comprehensive graph display as in figure.

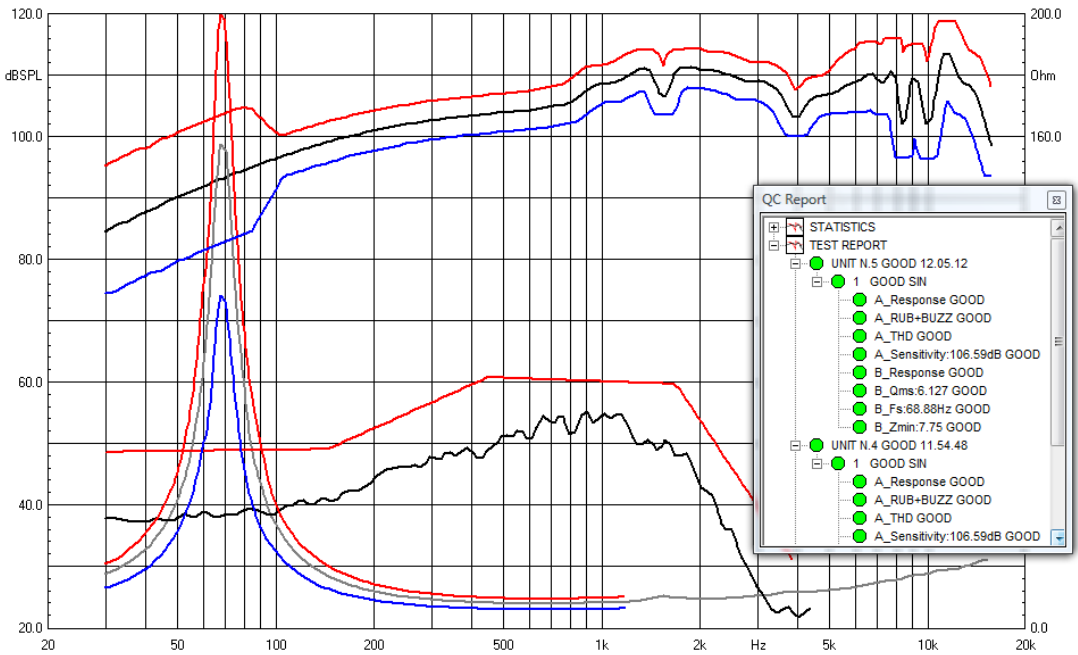

20.1.7 ADDING THE INTERFACE TO AUTOMATION

To manage TTL signals that connect the system QCBox Model 5 digital I/O port to the external automation we must include some programming inside CLIO and inside the QC script.

As we have chosen input Bit 2 to trigger the QC test we must set this inside CLIO Options>QC dialog.

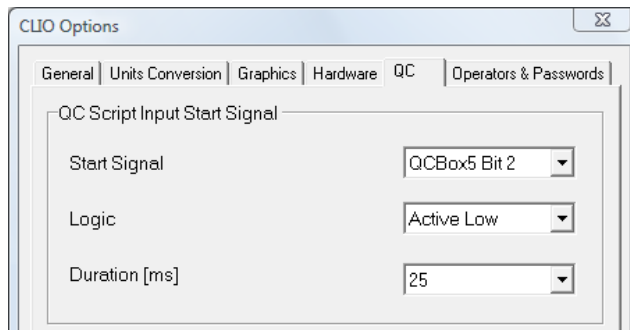

The output bits operation should be defined directly inside the QC script and should reflect how CLIO and the automation interact.

We suppose the following meaning of the output TTL bits:

BIT0 -> Signals the end of the sweep.

BIT1 -> Signals if result is good.

BIT2 -> Signals if result is bad.

The keywords that should be added to our script lead to the following situation

```
[PERFORM]
QCBOXOUTBYTE=0
```

```
[SIN]
OUTQCBOX=1V
INA=-10
INB=-30
REFERENCE=REFERENCE.SIN
LIMITSA=RESPONSE.LIM
LIMITSB=IMPEDANCE.LIM
POLARITY=1
```

```
[PERFORM]
QCBOXOUTBIT0=1
```

```
[IF ALL GOOD]
QCBOXOUTBIT1=1
```

```
[IF ALL BAD]
QCBOXOUTBIT2=1
```

Here you may see the initial keyword QCBOXOUTBYTE=0 that resets all three signals to zero. Then, after the test is finished they are set to reflect the end of sweep and the result of the test.

The only thing to be noted is that BIT0 (end of sweep) is output when the sinusoidal test is finished, i.e. right after all calculations and measurement managements are made. This means that it will be delayed with respect to the actual end of the sweep by the time the computer takes to make all the calculations and actions related to a sinusoidal test; this time is usually small but not zero and may range in some hundred of milliseconds depending on the platform chosen.

If very tight synchronization is needed and you want to save also this time it is possible to require that the signal is output right after the sweep is completed without waiting for the sinusoidal test to end; to do this, place the relative keyword right under the [SIN] definitions thus changing the script to:

```
[PERFORM]
QCBOXOUTBYTE=0
```

```
[SIN]
OUTQCBOX=1V
INA=-10
INB=-30
REFERENCE=REFERENCE.SIN
LIMITSA=RESPONSE.LIM
LIMITSB=IMPEDANCE.LIM
POLARITY=1
QCBOXOUTBIT0=1
```

```
[IF ALL GOOD]
QCBOXOUTBIT1=1
```

```
[IF ALL BAD]
QCBOXOUTBIT2=1
```

You can find these example files in the 'My Documents\Audiomatica\CLIO 10 EXAMPLES\EXAMPLE0' folder.

20.2 QC EXAMPLES

20.2.1 EXAMPLE 1: QC OF A MICROPHONE PREAMPLIFIER

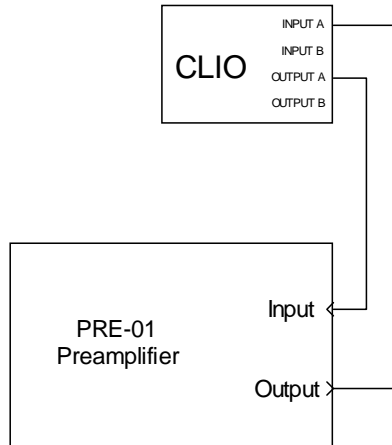

This example is taken from our internal QC procedure for the PRE-01 Microphone Preamplifier. Figure shows the connections required. The PRE-01 features three weighting filters and two gain positions. This test is a representative case of the following requirements:

- 1) The limits are **ABSOLUTE** as they are taken from the IEC tables for the specified tolerance. Since the perfect device has still to be built it is not possible to use relative limits from a real life measured reference.
- 2) The IEC specifies a response in term of a 0 dB at 1kHz. The absolute level at 1kHz is however left to the test procedure. As we want to perform the test near the highest level the device is able of accept, we need to use the **PROCESS** feature to shift the real measurement to the specs level.
- 3) Changes in switch position are required during test. We have therefore to use the **INTERACTIVE** feature.
- 4) A level regulation is required to align the gain at 1kHz with and without a filter. This brings in the **LOOP** feature of the [MET] multimeter test.
- 5) It's very difficult for the operator to set a switch accordingly to the next test to be performed. The **PERFORM** and **MESSAGE** feature greatly simplifies this, avoiding errors.

The QC script, described here with comments, allows the check of the filters response against Type 1 tolerance specification. It also checks for +/- 0.2 dB gain tolerance of the gain switch in both positions. As an additional feature it allows the user, within the test, to adjust a variable gain trimmer that has to be adjusted to achieve optimum levels; this procedure, **LOOP**, also ends with a check of the adjusted level to be within +/- 0.2 dB. At every level check a distortion test, **THD** defined in the LEV1.LIM file, is performed. As a general rule a QC procedure is defined from one QC file (.qc extension) and several limits file (.lim extension) declared in the qc file. Process files (.mpro or .spro) are also involved here and these are the only ones not specifically QC related. It is a good idea to dedicate a directory for each QC test. The files involved here are:

PRE01.QC

LEV1.LIM
A.LIM
B.LIM
C.LIM
ASHIFT.SPRO

You can find them in the 'My Documents\Audiomatica\CLIO 10
EXAMPLES\EXAMPLE1' folder.

[GLOBALS]
COMPANY=AUDIOMATICA S.R.L. FLORENCE
TITLE=PRE01 TEST PROCEDURE
INTERACTIVE=1
SAVEONBAD=1

[PERFORM]
MESSAGE=FILTER OFF DIP ON OFF OFF OFF

[MET]
OUT=2.44
IN=10
REFERENCE=FILTER.MET
LIMITS=LEV1.LIM

[PERFORM]
MESSAGE=FILTER ON DIP ON OFF OFF OFF

[MET]
OUT=2.44
IN=10
REFERENCE=FILTER.MET
LIMITS=LEV1.LIM
LOOP=1

[PERFORM]
MESSAGE=FILTER ON DIP ON OFF OFF ON

[MET]
OUT=-17.56
IN=10
REFERENCE=FILTER.MET
LIMITS=LEV1.LIM

[SIN]
OUT=-10
IN=10
REFERENCE=A.SIN
LIMITS=A.LIM
PROCESS=ASHIFT.SPRO

[PERFORM]
MESSAGE=FILTER ON DIP OFF ON OFF ON

[SIN]
OUT=-10

IN=10
REFERENCE=A.SIN
LIMITS=B.LIM
PROCESS=ASHIFT.SPRO

[PERFORM]

MESSAGE=FILTER ON DIP OFF OFF ON ON

[SIN]

OUT=-10

IN=10

REFERENCE=A.SIN

LIMITS=C.LIM

PROCESS=ASHIFT.SPRO

[PERFORM]

MESSAGE=SET DEFAULT SETTINGS FILTER OFF DIP ON OFF OFF ON

20.2.2 EXAMPLE 2: THE AMPLIFIER&SWITCHBOX UNDER QC

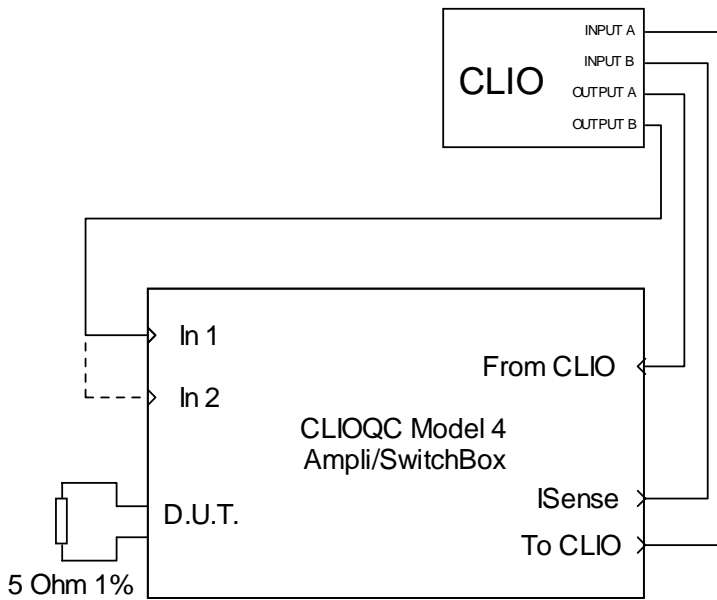

This example details the quality control procedure that Audiomatica uses to test its production of CLIOQC Amplifier & Switchbox.

A precision 5 Ohm 10W 1% resistor is needed and must be connected across DUT terminals. The procedure, executed in Interactive mode, guides the operator and requests the manual connection of the unit; the cable coming from output B of CLIO must be swapped during the test between input 1 and 2.

The test begins with two impedance measurements, the first executed in ISense Mode, the second executed in Internal Mode. Then a THD measurement with FFT and finally the frequency response of each input channel are performed.

Note the keywords used to alternatively mute CLIO's output.

```
[GLOBALS]
COMPANY=AUDIOMATICA S.R.L. FLORENCE
TITLE=QCBOX TEST PROCEDURE
INTERACTIVE=1

[PROMPT]
MESSAGE=CONNECT:
MESSAGE2=[OUTA->FROM CLIO][INA->TO CLIO][OUTB->CH1][INB->ISENSE]

[PROMPT]
MESSAGE=PLACE 5 OHM 1% RESISTOR ACROSS D.U.T. TERMINALS

[SETIMPEDANCE]
[SETMUTEB]

[PERFORM]
DELAY=500

[SIN]
```

```
OUT=0
IN=-20
REFERENCE=IMPEDANCE.SINI
LIMITS=IMPEDANCE.LIM
```

```
[SETINPUT1]
```

```
[PERFORM]
DELAY=500
```

```
[SIN]
OUT=10
IN=-20
REFERENCE=ISENSE.SINI
LIMITS=IMPEDANCE.LIM
```

```
[FFT]
OUT=10.0
IN=-10
ACQUISITIONDELAY=200
REFERENCE=FFT.FFT
LIMITS=FFT.LIM
```

```
[RESETMUTEB]
[SETMUTEA]
```

```
[PERFORM]
DELAY=500
```

```
[SIN]
OUT=10
IN=10
REFERENCE=CH.SIN
LIMITS=CH.LIM
```

```
[PROMPT]
MESSAGE=CONNECT:
MESSAGE2=[OUTB -> CH2]
```

```
[SETINPUT2]
```

```
[PERFORM]
DELAY=500
```

```
[SIN]
REFERENCE=CH.SIN
LIMITS=CH.LIM
```

```
[RESETMUTEA]
```

You can find the files of this example in the '**My Documents\Audiomatica\CLIO 10 EXAMPLES\EXAMPLE2**' folder.

20.2.3 EXAMPLE 3: A TEST ON A STEREO ELECTRONIC EQUIPMENT



The following self-explaining script implements the procedure required to test the frequency response of a stereo equipment; it is simulated by a couple of PRE-01 units each connected, as in the picture, to the two channels of CLIO. Both PRE-01 have A-weighting filter active; the unit connected to channel B has +20dB gain.

Beyond the frequency response of the two channels, the script also measure the A/B difference response and output it to QC screen.

```
[SIN]
OUT=0.0 dBV
INA=-10
INB=20
REFERENCE=PRE01_A_B20.SIN
LIMITSA=AB_A.LIM
LIMITSB=AB_B.LIM
```

You can find the files of this example in the 'My Documents\Audiomatica\CLIO 10 EXAMPLES\EXAMPLE3' folder.

20.2.4 EXAMPLE 4: A CYCLIC SCRIPT (USED TO MANAGE MY ROGERS LS3/5A TWO-WAY LOUDSPEAKER PRODUCTION)

This example describes a hardware and software setup to do quality control over a production of loudspeakers units; the responses are taken come from our samples of Rogers LS3/5A speakers. The hardware setup is shown in figure

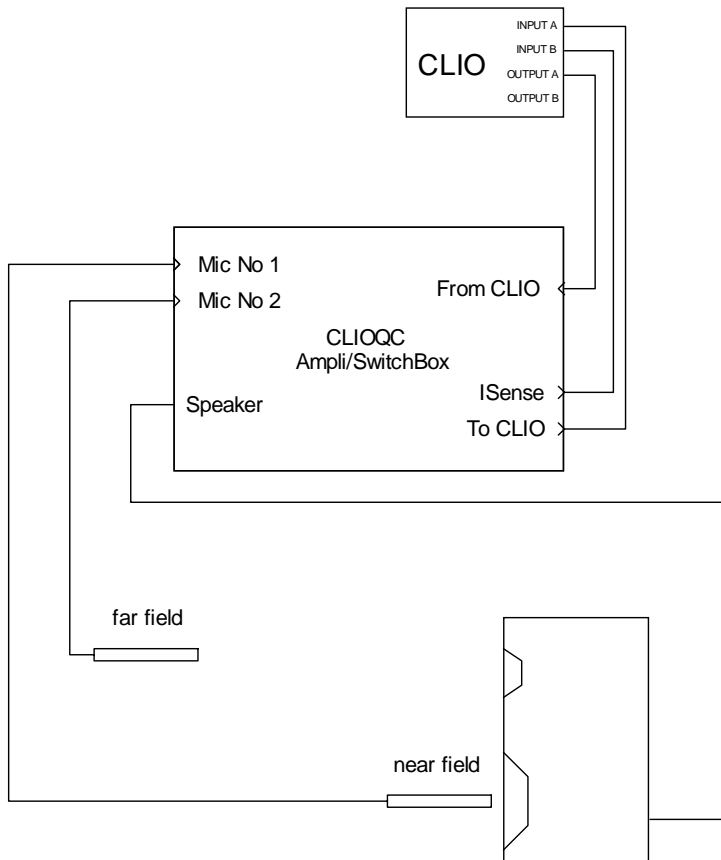

As you can see we employ a CLIOQC Amplifier & SwitchBox that connects two measuring microphones, one for near field response and the other for far field response. The internal switcher is used to configure impedance with current sensing or frequency response measurements and to select the correct microphone.

The quality control of such a production relies on what is called **a reference loudspeaker** i.e. a unit which is kept aside the line and retested regularly to give reference data curves for the units under test. These data trace environmental conditions.

To accomplish the recurrent operation of testing the reference loudspeaker CLIO QC implements what is called the **cyclic script** i.e. a QC script that is launched by the main script on a timed basis and executed once. When the cyclic script is launched the operator is prompted and the reference unit must be placed on the line.

The three keywords used to define this operation are CYCLIC, REPETITION and CYCLICFIRST under [GLOBALS]. CYCLIC defines the name of the cyclic script; this file must reside in the same directory of the calling one. REPETITION defines after how many units it is run; we put 4 in the example only to allow you to test it, this number is chosen after evaluating the particular condition of the production line. CYCLICFIRST, which in the example is commented away, tells the software to execute the cyclic script **before** the first run of the main script; this is useful to set known conditions at the beginning of a QC session.

Please note the use of the **OUTUNITS** keyword which accounts for output levels expressed in Volts RMS. With **OUTQCBOX=2.83** we chose to set 2.83 Volts at Rogers terminals.

The rest of the main script for producing my LS3/5As deals with the three actual measurements for testing nearfield, farfield and impedance data; the first two are done with MLS, the third with Sinusoidal. Before each measurement definition are the relative commands that set the correct function of the Amplifier & SwitchBox; note that the impedance is done in 'ISense' mode.

```
[SETINPUT1]
```

```
[MLS]  
REFERENCE=NEARFIELD.MLS  
LIMITS=NEARFIELD.LIM
```

```
[SETINPUT2]
```

```
[MLS]  
REFERENCE=FARFIELD.MLS  
LIMITS=FARFIELD.LIM
```

```
[SETISENSE]
```

```
[SIN]  
OUTQCBOX=1  
IN=-30  
REFERENCE=IMPEDANCE.SINI  
LIMITS=IMPEDANCE.LIM
```

The main QC script ends here. It is a fairly simple one, which can be customized for any production of loudspeakers. Let's now see the cyclic script. The basic idea is to execute the same measurements as in the main script and save them with the names of the reference files for the main script itself. AUTOSAVE=1 prepares for saving all the measurements done; SAVEFOLDER= is a particular syntax to set the script directory as the current one.

```
[GLOBALS]  
AUTOSAVE=1  
SAVEFOLDER=  
OUTUNITS=V  
OUTQCBOX=2.83  
IN=-20
```

The rest of the cyclic script resembles the main script with the difference that after each measurement, we define the name of the file to be saved and force it to be equal to the name of the reference file; in this way the reference file itself is updated. SAVEPROMPT=1 instructs the QC processor to prompt for user acceptance of the save operation; this is useful for validating the procedure and avoiding errors.

```
[SETINPUT1]
```

```
[MLS]  
REFERENCE=NEARFIELD.MLS
```



```
LIMITS=NEARFIELD.LIM
SAVENAME=NEARFIELD
SAVEPROMPT=1
```

```
[SETINPUT2]
```

```
[MLS]
```

```
REFERENCE=FARFIELD.MLS
LIMITS=FARFIELD.LIM
SAVENAME=FARFIELD
SAVEPROMPT=1
```

```
[SETISENSE]
```

```
[SIN]
```

```
OUTQCBOX=1
IN=-30
REFERENCE=IMPEDANCE.SINI
LIMITS=IMPEDANCE.LIM
SAVENAME=IMPEDANCE
SAVEPROMPT=1
```

You can find the files of this example in the '**My Documents\Audiomatica\CLIO 10 EXAMPLES\EXAMPLE4**' folder.

20.2.5 EXAMPLE 5: QUALITY CONTROL OF A TELEPHONE WITH LOUDNESS RATING CHECK

We describe here the quality control test of the production of a telephone unit.

Two script files take part to this example.

The cyclic script "moutheq.qc" is needed to measure and save the output pressure response of the reference speaker or mouth at reference position.

```
[GLOBALS]
AUTOSAVE=1
SAVEFOLDER=
[PERFORM]
MESSAGE=PLACE REFERENCE MICROPHONE IN PLACE
[SIN]
OUT=-28 dBu
IN=-10
REFERENCE=MOUTH.SIN
LIMITS=NONE
SAVENAME=MOUTH
```

The main script "phone.qc" tests the frequency response of the phone under test equalizing the drive pressure at -4.7 dBPa; also defined inside the "phone.lim" limits file a Send Loudness Rating QC check.

```
[GLOBALS]
CYCLIC=MOUTHEQ.QC
CYCLICFIRST=1
REPETITION=100
[PERFORM]
MESSAGE=PLACE TELEPHONE IN PLACE
[SIN]
OUT=-4.7
IN=-10
EQREFERENCE=MOUTH.SIN
REFERENCE=REFPHONE.SIN
LIMITS=PHONE.LIM
```

You can find the files of this example in the 'My Documents\Audiomatica\CLIO 10 EXAMPLES\EXAMPLE5' folder.

20.2.6 EXAMPLE 6: ON RUB & BUZZ DETECTION (1)

This example describes an effective technique to detect rub&buzz in a production line of loudspeakers. The technique is based on logarithmic chirp stimulus with synchronous FFT detection.

CLIO is able to generate (see 7.7) logarithmic chirps of proper length and proper start and stop frequencies.

Given your production of speakers you should program the log chirp following these guidelines:

Frequency Range. The frequency extremes depend on the kind of speaker; the start frequency must be below the resonant frequency (F_s) to achieve excursion while the stop frequency should be high enough to stimulate all possible defects and anomalous mechanical contacts. We suggest start to lie between **20Hz/100Hz** while stop between **500Hz/1500Hz**. Stop should be a compromise between best defect detection and anomalous resonances excitation.

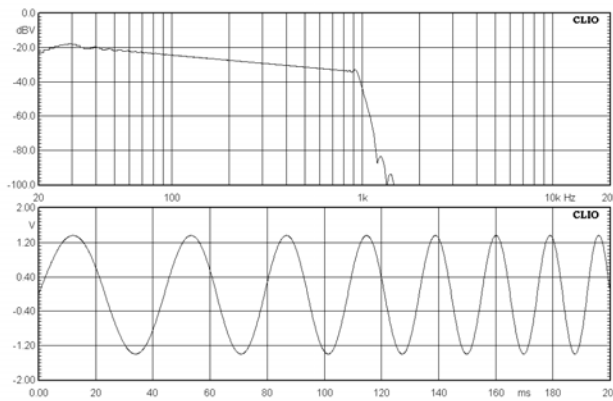

Amplitude. Perhaps this is the most critical parameter to set. Its choice must take into consideration T&S parameters of the device and tend to exploit the maximum excursion possible (X_{Max}). On the other side a too high stimulus amplitude will tend to give false positives to R&B. The graph below shows excursion normalized versus Q_t and F_s ; it tells us that, in free air (as it is usually the case of production lines), maximum excursion is reached well below F_s (around $0.1 * F_s$).

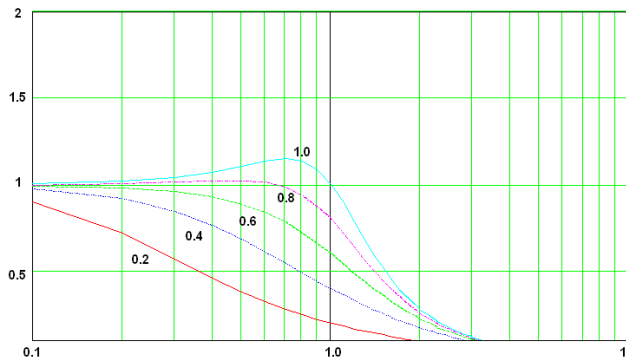

This leads us also to consider the technique described after (19.9.9) to apply DC and relax other parameters while augmenting R&B detection.

Duration. It is directly related to the chirp length; at 48 kHz sampling you get the following: a 16k chirp lasts around 0.35s, a 32k chirp lasts around 0.7s, a 64k chirp lasts around 1.4s and so on.

The choice should be consistent with your production test needs provided a longer test should be preferable as some kind of R&B phenomena appear with time as device thermal constants are reached. For the same reason if R&B is one among other QC tests, it should be done **at the end**.

Once the stimulus has been defined you must define a proper FFT QC test; be sure to use the same size of the stimulus, i.e. **FFT Size = Chirp Size**. Another important FFT parameter to set is smoothing which will present an easier to detect analysis; we suggest 1/48 or 1/24th of octave smoothing.

The analysis leads to the following situation:

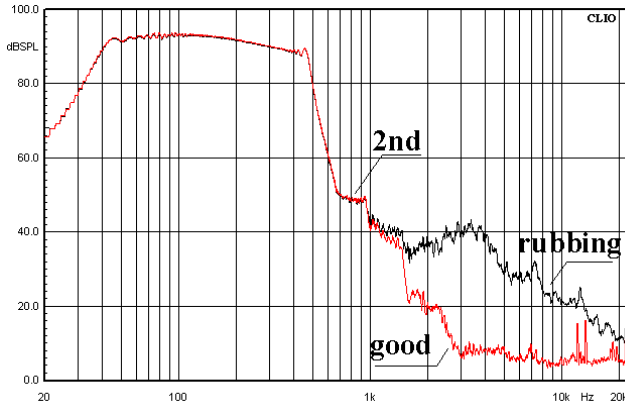

You can see the response of a good and a rubbing device which will lead you to correct mask definition; it is also shown how this measurement detects the harmonic signature of the device; the plateau marked with 2nd directly refers to second harmonic response.

This QC test is as simple as the following definition:

```
[FFT]
COMMENT=RUB&BUZZ
QCBOXDCOUT=2.83
IN=0
REFERENCE=RUB.FFT
LIMITS=RUB.LIM
```

We set 2.83V at the QCbox output (given a former OUTUNITS=V definition) and input at 0dBV. **Extreme care must be put in order to optimize input sensitivity** as this measurement is very sensitive to noise.

Limits mask should be placed in the decaying part of the acquisition and extended to cover the highest frequencies; only upper limit is necessary in this case.

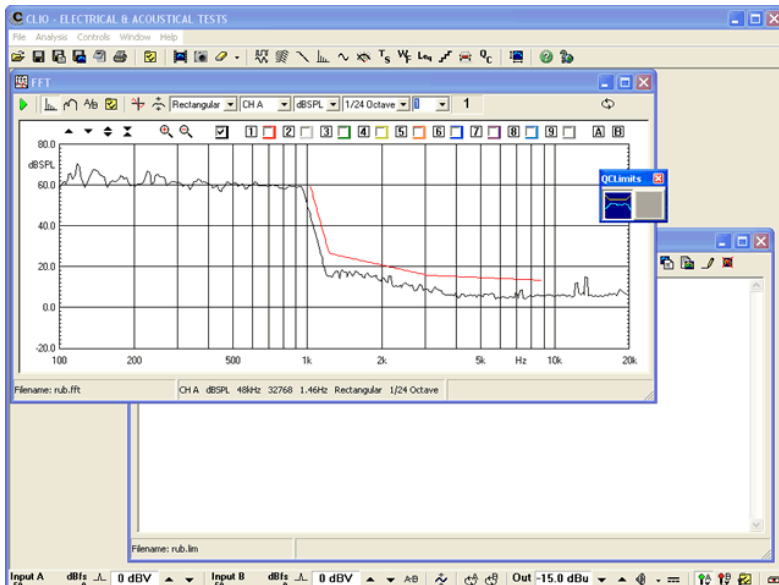

20.2.7 EXAMPLE 7: ON RUB & BUZZ DETECTION (2)

This example describes a simple method to enhance rub&buzz detection. This method is based on the possibility of applying a DC voltage superimposed to the generated stimulus. This technique applies to any test possible with CLIO and augments its sensitivity.

As it is evident also from the figures in 19.9.7 the maximum excursion is obtained at DC and this is an effective way to bring the speaker to its limits. As it is evident from the following figure when a DC is applied the corresponding AC signal amplitude must be lowered to obtain similar excursion.

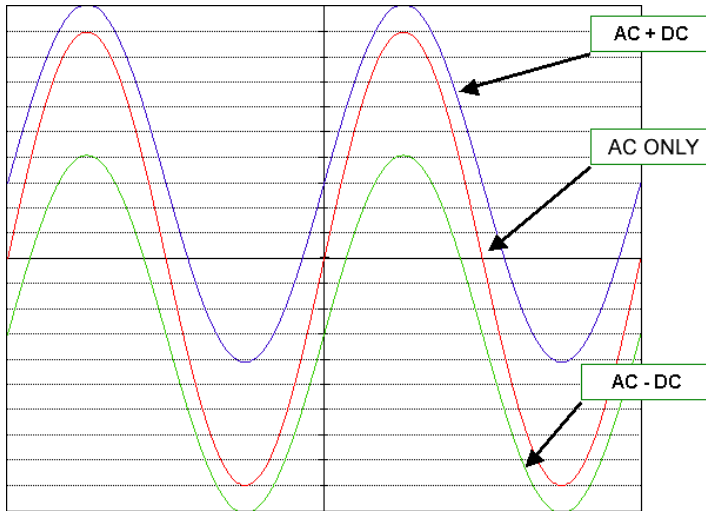

Applying a DC to the same QC test as described before in 19.9.8 it is possible to obtain the following measurement where it is evident the much better detection of the defect which is possible.

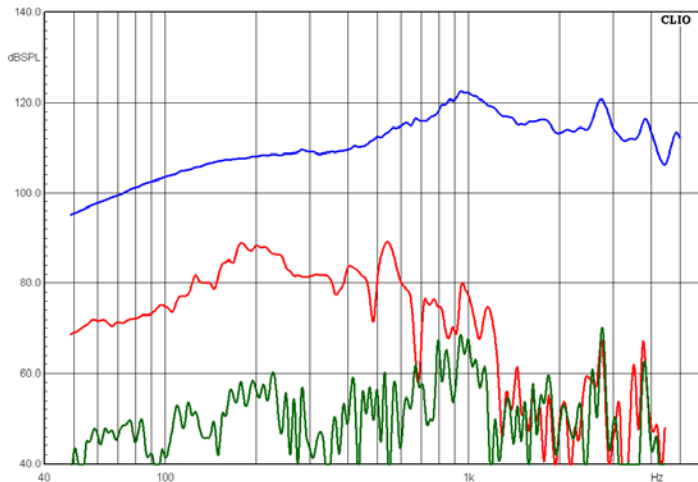

As described in 4.6.1 it is possible to manually set the DC voltage at the output of a QCBox Model 5 using the relative control panel.

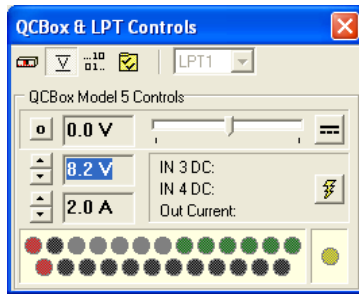

Under a QC script it is possible to apply DC with the following syntax:

```
[ PERFORM]
QCBOXDCOUT=1.2
[ SIN]
REFERENCE=RESPONSE.SIN
LIMITS=RESPONSE.LIM
[ PERFORM]
QCBOXDCOUT=1.2
[ SIN]
REFERENCE=RESPONSE.SIN
LIMITS=RESPONSE.LIM
[ PERFORM]
QCBOXDCOUT=0
```

In this example it has been applied a 1.2V DC voltage to a sinusoidal test; the same could have been applied to a FFT with log chirp or any other test; **to be noted that the same test must be executed twice** as we don't know a priori which direction stimulates the defect to arise.

In this case also lower harmonics could be checked as, when DC is present, they become sensitive to R&B too.

20.3 CLIO QC TCP/IP SERVER

This is the CLIO answer to the general request of being able to control and use QC features inside custom applications.

It is an imperative need when audio testing is a part of a more complex QC process (like in a cell phone QC test procedure when you must test also the display and other parts).

The choice of TCP/IP approach presents several advantages:

- 1) No additional learning curve as same CLIO QC script commands are used
- 2) Prevents the engineer to deal with complex API programming
- 3) It is independent from the Operating System, Programming Language and kind of PC.
- 4) It can be run locally or from another network connected PC
- 5) It is possible to write applications that control more than one QC test workstation

20.3.1 INVOKING THE QC SERVER

To invoke the CLIO quality control server simply run CLIO passing it the "TCP" parameter. You may define a shortcut with the following target program:

"C:\Program Files\Audiomatica\CLIO 10\Clio.exe TCP"

CLIO will run and start listening on the port defined in the CLIO Options>QC settings dialog (see also 19.4.8) being port 1234 the default one.

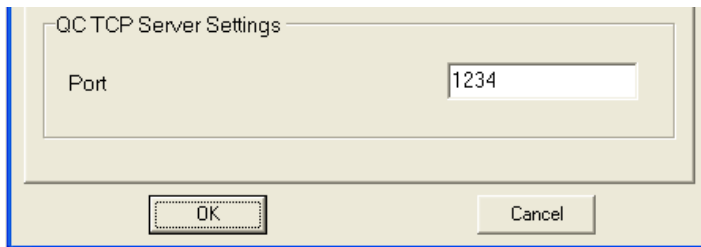

The CLIO desktop will also show this particular operating condition in the main toolbar:

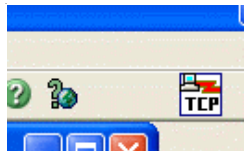

From this moment it is possible to connect to CLIO and receive the various measurements services that it is capable of.

20.3.2 CONNECTING TO THE QC SERVER

It is possible to connect to the CLIO QC server with any custom written client application that opens a TCP socket (we will see an example later) or with a standard telnet application (like Microsoft Telnet).

The connections parameters are:

hostname Network name of PC or 'localhost' for same PC

port CLIO TCP port (default 1234)

Let's see how to connect a telnet client application (we will use CRT 3.4) run in the same computer where CLIO resides.

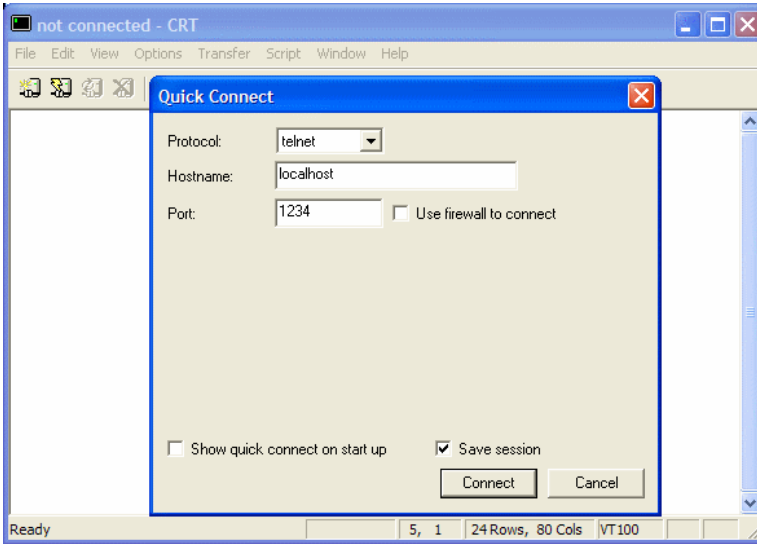

As soon as the connection is invoked the CLIO QC server will answer with the welcome greeting:

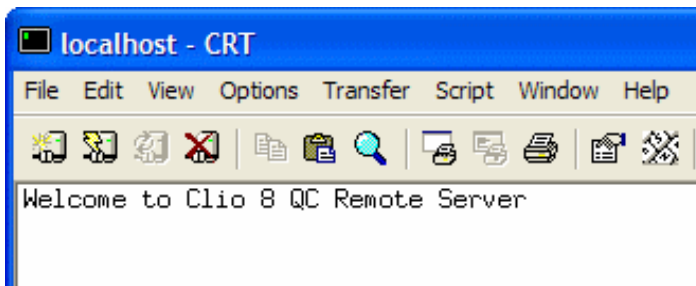

The connection is established! QC services are ready for you.

20.3.3 INTERACTING WITH THE QC SERVER

Your client application interacts with CLIO sending the standard ASCII script commands; CLIO executes the commands and sends back the result of the measurements.

Let's now execute a simple MLS measurement. We will use the same example of 19.5.2 (My First QC Script). The synthax is identical:

```
[MLS]
OUT=0.0
IN=0
REFERENCE=LOOP.MLS
LIMITS=LOOPMLS.LIM
```

If we send these commands to CLIO we get the following:

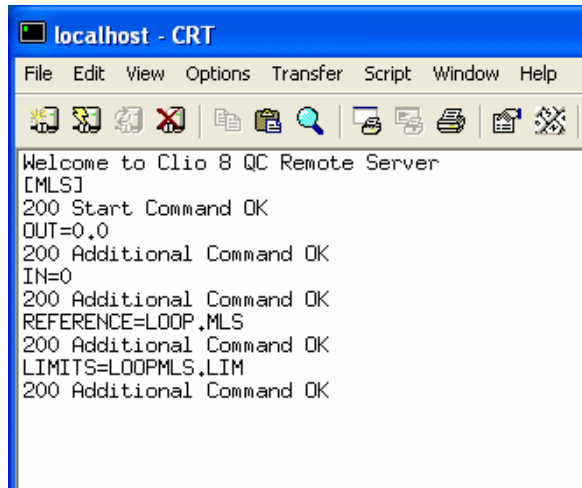

```
localhost - CRT
File Edit View Options Transfer Script Window Help
Welcome to Clio 8 QC Remote Server
[MLS]
200 Start Command OK
OUT=0.0
200 Additional Command OK
IN=0
200 Additional Command OK
REFERENCE=LOOP.MLS
200 Additional Command OK
LIMITS=LOOPMLS.LIM
200 Additional Command OK
```

You can see how the data exchange takes place. After each line of command is sent the server sends back an acknowledgement stating that the command has been received and that it is ok. At this time the sequence has not been closed yet and the measurement has not been done. The server needs to know that the sequence of commands that defines the measurement has ended; there is the special execute command `[]` (two empty brackets) that is needed, at the end, to tell CLIO to execute the measurement.

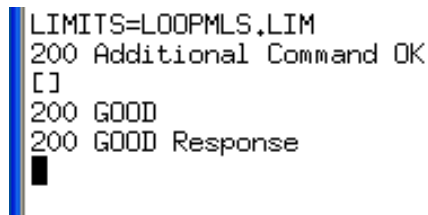

```
LIMITS=LOOPMLS.LIM
200 Additional Command OK
[]
200 GOOD
200 GOOD Response
█
```

After we give the execute command (`[]`) the measurement starts and the result is fed back to our application. The first line of the result is the global test result while each subsequent line details all the single checks that have been done and that participate to the global result.

To see more tests in action we may add a level check and a polarity test.

To do this we must add the following to the limits file 'loopm1s.lim':

```
[LEVEL]
UPPER=2
LOWER=-2
```

And we must add the following to the commands sent:

```
POLARITY=1
```

We get the following situation:

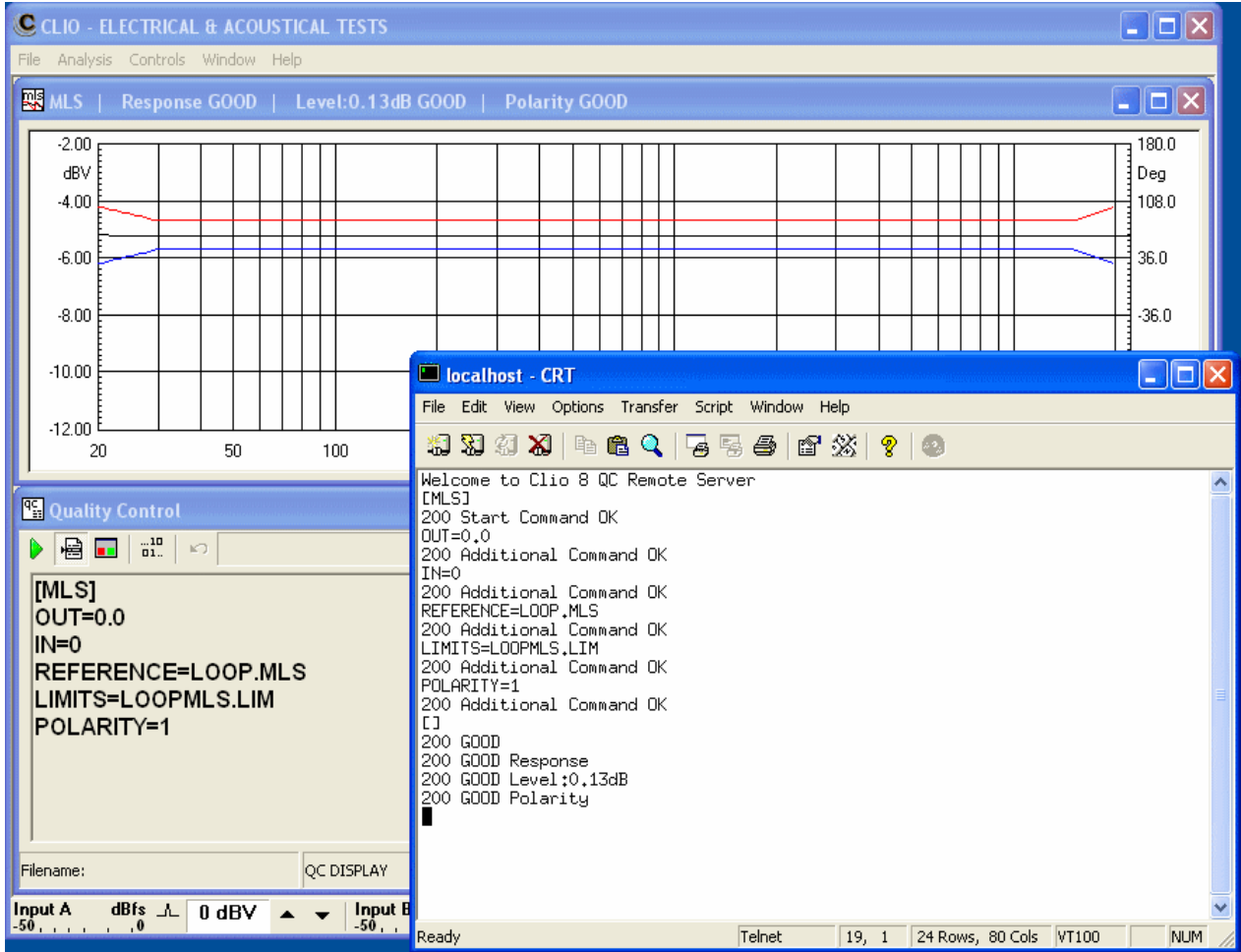

You notice now that the result is detailing all the three checks that the MLS measurement has done (response, global level and polarity).

The example details how to execute a measurement; single commands can also be sent that perform all standard operations. To close the channel A in-out loop simply send CLIO the following:

```
[SETLOOPA]
[ ]
```

In the above example CLIO is behaving as a server and is visible on the Windows Desktop.

It is possible to hide CLIO from end user sending the command:

```
[HIDECLIO]
```

[]

; CLIO will disappear and remain minimized in the Windows application bar; to see CLIO again send:

[SHOWCLIO]

[]

20.3.4 NOTES ABOUT QC SERVICES

The Quality Control operation when requesting TCP services differs from the normal condition when the QC Script processor is active. In this case many tasks are handled by the client application that is requesting the services and are not performed by CLIO; for example there is no serial number management.

The main difference is that no QC test, formed by various single measurements, is defined and managed by CLIO like in a QC script; the TCP server can be configured and then executes endlessly all the commands and measurements it is requested to do; it has no knowledge of how many single measurements form a complete QC test.

TCP Operation and Server messages

When dealing with a network service like the CLIO TCP server the client application receives back answers for each text command sent.

We find the following server responses:

200 Start Command OK

Usually given when a bracketed keyword is sent

200 Additional Command OK

Usually given when a keyword defining a section is sent

400 Unknown Command

400 Unknown Additional Command

200 OK Given when a command (not a measurement) is executed

200 GOOD

Global result given at the end of a measurement

200 BAD Global result given at the end of a measurement

200 GOOD Response, 200 GOOD Polarity etc. etc.

Single results given at the end of a measurement

Note the particular syntax of these answers. They are all initiated by a number that is related to network operation and gives information about the correct interaction between client and server. We find:

200 Correct

400 Usually an error is occurred

Autosaving

During TCP operation the QC **single test numbering** is disabled and does not take place in defining the name of the autosaved data file (see 19.7.3). If autosaving is active CLIO will give the following names to files:

'**tcpresponse.txt**' measurements exported in ASCII

'**tcpresponse.mls**' MLS measurements

'**tcpresponse.sin**' Sinusoidal measurements

'**tcpresponse.fft**' FFT measurements

'**tcpresponse.met**' Multimeter measurements

Please note also the following differences with standard QC operation:

- No serial number management is performed
- No batch management is performed
- No production report files are saved
- No statistical information are calculated

20.3.5 KEYWORDS FOR QC SERVICES

All the keywords available to the QC scripts processor (see 19.11) are valid, with few exceptions, and can be sent to the TCP server. There are some specific keywords that are listed below.

[] Special keyword that tells the TCP server to execute the command or measurement input.

[HIDECLIO]

Enables background execution of TCP server. The CLIO desktop will not be visible.

[SHOWCLIO]

Resets normal operation of CLIO when TCP server is active. The CLIO desktop will be visible.

NOREPORTSAVED

=1 No detailed information are sent back by the TCP server. Only the global result will be sent.

=0 The TCP server sends all the information about executed measurements beyond the global test result.

If omitted defaults to 0.

QCWORKDIR

Defines the folder where the reference and limits files reside.

If omitted defaults to the current folder of CLIO.

20.3.6 TCP SERVER EXAMPLE: A C++ CLIENT APPLICATION

A fully commented sample C++ client console application that is able to connect to CLIO, request measurements and receive results follow:

```
/* clio client c - code for example client program that uses TCP */

#include <windows.h>
#include <winsock.h>
#include <stdio.h>
#include <string.h>

#define PROTOPORT          1234                /* default protocol port number */

extern int                 errno;
char    localhost[] =    "localhost";        /* default host name          */
/*-----
 * Program:      clioclient
 *
 * Purpose:     allocate a socket, connect to the Clio Server, interact with
 *              the QC environmet
 *
 * Syntax:      client [ host [port] ]
 *
 *              host - name of a computer on which server is executing
 *              port - protocol port number server is using
 *
 * Note:        Both arguments are optional.  If no host name is specified,
 *              the client uses "localhost"; if no protocol port is
 *              specified, the client uses the default given by PROTOPORT.
 *-----
 */
int string_length(char str[]);

main(argc, argv)
int    argc;
char   *argv[];
{
    struct hostent *ptrh; /* pointer to a host table entry      */
    struct protoent *ptrp; /* pointer to a protocol table entry */
    struct sockaddr_in sad; /* structure to hold an IP address  */
int    sd;                /* socket descriptor              */
int    port;              /* protocol port number            */
char   *host;             /* pointer to host name            */
int    n;                 /* number of characters read        */
char   ibuf[100];         /* buffer for data from the server  */
char   obuf[100];         /* buffer for data to the server    */

    WSADATA wsaData;
    WSASStartup(0x0101, &wsaData);

    memset((char *)&sad,0,sizeof(sad)); /* clear sockaddr structure */
    sad.sin_family = AF_INET;           /* set family to Internet   */

    /* Check command-line argument for protocol port and extract
     * port number if one is specified.  Otherwise, use the default
     * port value given by constant PROTOPORT
     */

    if (argc > 2) { /* if protocol port specified */
        port = atoi(argv[2]); /* convert to binary */
    } else {
        port = PROTOPORT; /* use default port number */
    }
    if (port > 0) /* test for legal value */
        sad.sin_port = htons((u_short)port);
    else { /* print error message and exit */
        fprintf(stderr,"bad port number %s\n",argv[2]);
        exit(1);
    }
}
```

```

/* Check host argument and assign host name. */

if (argc > 1) {
    host = argv[1];          /* if host argument specified */
} else {
    host = localhost;
}

/* Convert host name to equivalent IP address and copy to sad. */

ptrh = gethostbyname(host);
if ( ((char *)ptrh) == NULL ) {
    fprintf(stderr,"invalid host: %s\n", host);
    exit(1);
}
memcpy(&sad.sin_addr, ptrh->h_addr, ptrh->h_length);

/* Map TCP transport protocol name to protocol number. */

if ( ((int)(ptrp = getprotobyname("tcp"))) == 0) {
    fprintf(stderr, "cannot map \"tcp\" to protocol number");
    exit(1);
}

/* Create a socket. */

sd = socket(PF_INET, SOCK_STREAM, ptrp->p_proto);
if (sd < 0) {
    fprintf(stderr, "socket creation failed\n");
    exit(1);
}

/* Connect the socket to the specified server. */

if (connect(sd, (struct sockaddr *)&sad, sizeof(sad)) < 0) {
    fprintf(stderr,"connect failed\n");
    exit(1);
}

/* Wait a little */

n=0;
while (n < 1000000) {n=n++;
}

/* Get greeting message */

n = recv(sd, ibuf, sizeof(ibuf), 0);
write(1,ibuf,n);

/* Repeatedly read write data from socket or stdin and write to user's screen. */

while (strcmp(obuf,"exit\n")) {
    fgets(obuf,127,stdin);
    n = send(sd, obuf, string_length(obuf), 0);
    n = 0;
    while (n < 1000000) {n = n++;
}
    n = recv(sd, ibuf, sizeof(ibuf), 0);
    write(1,ibuf,n);
}

/* Close the socket. */

closesocket(sd);

/* Terminate the client program gracefully. */

exit(0);
}

```



```
int string_length(char str[])
{
    int i;
    for(i = 0; i < 80; i++)
    {
        if(str[i] == '\0')
        {
            return(i);
        }
    }
}
```

You can find the file of this example in the **'My Documents\Audiomatica\TCP Server'** folder.

20.4 QC SCRIPT SYNTAX REFERENCE

20.4.1 KEYWORDS FOR GENERAL SETTINGS

NOTE: "**SCRIPTDIR**" means the directory where the QC script is saved.

[GLOBALS]

Starts a section containing settings and definitions valid for the whole test sequence.

AUTOBATCH

=1 Enables automatic batch naming. The name of the production batch is set equal to the current name of the folder where the QC script is saved (SCRIPTDIR).

=0 Does not perform autobatch. If omitted defaults to 0.

AUTOREPEAT

=n Number of QC tests to be executed continuously without operator assistance. After pressing Go the QC processor will execute "n" tests and then stop.

AUTOSAVE =1 Autosaves all measurements. Applies to all measurements.

=0 Does not perform autosave. If omitted defaults to 0.

AUTOSN =1 Automatically manages and increments an 8-digits numerical serial number.

=0 Permits a 24 alphanumeric serial number to be fed to the QC processor; no automatic increment is performed.

If omitted defaults to 1 i.e. automatic serial numbering.

AUXMONITOR

=1 Activates the math operation monitor panel during QC execution.

=0 Does not activate the math operation monitor panel.

If omitted defaults to 0.

BATCH Name of the production batch. See also AUTOBATCH and SAVEFOLDER.

CYCLIC Name of the cyclic script. The cyclic script is executed every REPETITION times instead of the actual script. All measurements executed inside the cyclic script do not take part in production report, batch management and serial numbering. See also CYCLICFIRST.

CYCLICFIRST

=1 Executes the cyclic script before executing the QC test itself.

If omitted defaults to 0 i.e. no cyclic script executed first.

Refer also to CYCLIC and REPETITION for defining the cyclic script behavior.

COMPANY Text used as the first title of the QC control panel. Usually the company name.

DELAY Value in milliseconds of a pause to be performed.

DISPLAY =1 displays the result of each measurement.

=0 executes all the measurements without displaying.

If omitted defaults to 1 i.e. DISPLAY.

DISPLAYONBAD

=1 displays the measurement if bad. Applies to all the measurements.
=0 Not active. If omitted defaults to 0.

DISPLAYTIME

Approximate time of display (in ms) when in DISPLAY mode.

IN

Sets the input sensitivity for both input channels.

INA

Sets channel A input sensitivity; channel B sensitivity remains untouched.

INB

Sets channel B input sensitivity; channel A sensitivity remains untouched.

INITIALBITS

8-BIT binary value that will be output from LPT port at startup before QC script execution.

INCREASEONBAD

=1 Increases serial number when unit is bad.
=0 Does not increase serial number when unit is bad.
If omitted defaults to 1 i.e. increases on bad.

INTERACTIVE

=1 displays the result of each measurement and prompts.
=0 executes all the measurements without prompting.
If omitted defaults to 0 i.e. NOT INTERACTIVE.

MANUAL

=1 starts the QC sequence manually (pressing Go).
=0 the sequence is started by an external trigger signal.
If omitted defaults to 1 i.e. MANUAL.

MESSAGEONBAD

Text to be displayed when unit performs bad.
If omitted defaults to 'BAD'

MESSAGEONGOOD

Text to be displayed when unit performs good.
If omitted defaults to 'GOOD'

NOREPORTSAVED

=1 No production report files are saved. See 19.7.2.
=0 The report informations are saved.
If omitted defaults to 0.

OPENSERIAL

Opens the QC COM port for serial communication. See 6.3.6 for RS-232 settings. See also SERIALMONITOR.

OUT

Sets the generator output level (with OUTUNITS defined under [GLOBALS]).

OUTQCBOX

Sets the generator output level taking into account QCBox gain (with OUTUNITS defined under [GLOBALS]). This is the level that will be present at QCBox output.

OUTUNBALANCED

=1 Consider output level settings as unbalanced.

=0 Consider output level settings as balanced.
If omitted defaults to balanced output.

OUTUNITS Sets the unit of measure of the output level. It is possible to set dBu, dBV or V.
If omitted defaults to dBu.

PHANTOM =1 Switches phantom power supply on.
=0 Switches phantom power supply off. If omitted defaults to 0.
Valid through all the QC test sequence.

PHANTOMA
=1 Switches phantom power supply for channel A on.
=0 Switches phantom power supply for channel A off. If omitted defaults to 0. Valid through all the QC test sequence.

PHANTOMB
=1 Switches phantom power supply for channel B on.
=0 Switches phantom power supply for channel B off. If omitted defaults to 0. Valid through all the QC test sequence.

PROMPTFORGOOD
=1 Prompts when unit is bad for user acceptance and overrides result.
=0 No prompt when unit is bad.
If omitted defaults to 0 i.e. no prompt.

QCBOXCURRENTLIMIT
Current limit (A) for Model 5 operation. Ranges from 0 to 10.

QCBOXDCOUT
DC voltage (V) to be output by Model 5 superimposed to generated signal.
Ranges from -20 to 20.

QCBOXINITIALBYTE
8-BIT binary value that will be output from Model 5 port at startup before QC script execution.

QCBOXOUTBIT0
Status (=1 or =0) of the bit that will be output from Model 5 BIT0.

QCBOXOUTBIT1
Status (=1 or =0) of the bit that will be output from Model 5 BIT1.

QCBOXOUTBIT2
Status (=1 or =0) of the bit that will be output from Model 5 BIT2.

QCBOXOUTBIT3
Status (=1 or =0) of the bit that will be output from Model 5 BIT3.

QCBOXOUTBIT4
Status (=1 or =0) of the bit that will be output from Model 5 BIT4.

QCBOXOUTBIT5
Status (=1 or =0) of the bit that will be output from Model 5 BIT5.

QCBOXOUTBYTE
8-BIT binary value that will be output from Model 5 port.

QCBOXPHANTOM

Microphone power supply voltage (V) set for Model 5 IN1 and IN2 input.
Ranges from 2 to 24.

RESETRESULTCOLOR

=1 If multiple tests of the same kind (MLS, FFT, MET, SIN) are present resets the result color of the menu display to match the last test of that kind.
=0 If multiple tests of the same kind are present maintains the color of a bad result if any.
If omitted defaults to 0 i.e. persistent color.

REPETITION

Number representing the frequency of execution of the cyclic script.

SAVEBINARY

=1 saves also in binary format if SAVETEXT=1. Ignored if used alone. Applies to all the measurements. If omitted defaults to 0. Remember that if neither SAVETEXT nor SAVEBINARY are specified the default format is binary.

SAVEFOLDER

Forces the name of the autosave directory. If omitted the default autosave directory is SCRIPTDIR\AUTOSAVE if no batch name is defined, otherwise it is SCRIPTDIR\BATCH where BATCH is the name of production batch.
If you desire to save files in the script directory itself use the particular syntax "SAVEFOLDER=" i.e. leave blank the right part.

SAVEONGOOD

=1 Autosaves all measurements, if global result is good. Applies to all measurements.
=0 Does not perform autosave. If omitted defaults to 0.
If you want to autosave also in case of bad measurement add the keyword SAVEONBAD=1 under [GLOBALS].

SAVEONBAD

=1 Autosaves all measurements, if global result is bad. Applies to all the measurements.
=0 Not active. If omitted defaults to 0.
Refer also to SAVEONGOOD and AUTOSAVE.

SAVETEXT =1 saves ASCII file instead of binary format. Applies to all the measurements.
=0 saves files with normal binary format. If omitted defaults to 0.

SERIALMONITOR

=1 Activates the RS-232 monitor panel during QC execution.
=0 Does not activate the RS-232 monitor panel. If omitted defaults to 0.

STARTSIGLOGIC

Defines the logic of the external trigger signal.
=1 is active high.
=0 is active low.
If omitted defaults to 0 i.e. active low.

STATISTICS

=1 Enables statistical data files generation.
=0 Disables statistical data files generation. If omitted defaults to 0.

STATFILESRES

Number of data lines present in statistical frequency files; maximum is 2048.

TITLE Text used as the second title of the QC control panel. Usually a description of the test.

WYSIWYG =1 Enables wysiwyg processing. Valid only for MLS tests.
=0 Disables wysiwyg processing. If omitted defaults to 0.

20.4.2 KEYWORDS FOR MEASUREMENTS SETTINGS

- [FFT] Starts a section containing the definition of an FFT measurement.
- [MLS] Starts a section containing the definition of an MLS measurement.
- [SIN] Starts a section containing the definition of a Sinusoidal measurement.
- [MET] Starts a section containing the definition of a Multimeter measurement.

ACQUISITIONDELAY

Approximate time in milliseconds that is expected before executing the measurement after switching the generator on. Valid only for FFT and Multimeter measurements.

COMMENT Input a text comment used by the report files. This text is also output, during the script execution, in the measurement title bar.

DISPLAYONBAD

=1 displays the measurement if bad.
=0 Not active. If omitted defaults to 0.

EQREFERENCE

Name of a reference frequency response file used to equalize generator output response in a sinusoidal measurement (see EQUALIZE). In this case the output level settings refer to the same units of the eqreference file and set output level accordingly.

IN Sets the input sensitivity for both input channels.

INA Sets channel A input sensitivity; channel B sensitivity remains untouched.

INB Sets channel B input sensitivity; channel A sensitivity remains untouched.

LIMITS Name of the limits file. Applies to both channel if stereo and LIMITSB is not present.

LIMITSA Name of the limits file for channel A in stereo measurements.

LIMITSB Name of the limits file for channel B in stereo measurements.

LOOP =1 Loops the current Multimeter measurement to let the user perform an adjustment on the unit under test.
=0 Executes the Multimeter measurement and exits.
If omitted defaults to 0.

MODE =DIFFERENCE Executes the measurement referring it to the reference file. Valid only for MLS and Sinusoidal measurements.
=NORMAL Executes the measurement normally.
If omitted defaults to NORMAL

OPERAND n A

OPERAND n B

Define the operands of a mathematical operation (as described in 19.11.3). n denotes the relative operands number; n may range from 0 to 9. Possible operands are:

LEVEL	(MLS,sinusoidal,FFT)
SENSITIVITY	(MLS,sinusoidal,FFT)
FS	(T&S)
QTS	(T&S)
OES	(T&S)
QMS	(T&S)
VAS	(T&S)
BL	(T&S)
MMD	(T&S)
MMS	(T&S)
DBSPL	(T&S)
ZMIN	(T&S)
RLR	(MLS,sinusoidal)
SLR	(MLS,sinusoidal)
STMR	(MLS,sinusoidal)
FREQUENCY	(multimeter)
IMD	(multimeter)
PRESSURE	(multimeter)
THD	(multimeter)
VOLTAGE	(multimeter)

When measurement is stereo you may append (A) or (B) to identify channel; VAS(B) refer to the Vas T&S parameter calculated for an impedance measurement done with channel B.

OUT Sets the generator output level (with OUTUNITS defined under [GLOBALS]). See also EQREFERENCE.

OUTQCBOX Sets the generator output level taking into account QCBox gain (with OUTUNITS defined under [GLOBALS]). This is the level that will be present at QCBox output. See also EQREFERENCE.

POLARITY =1 Executes a polarity check. Valid for an MLS or Sinusoidal measurement.
=0 Not Active. If omitted defaults to 0.

PROCESS Name of a process file to be applied to the test. Valid only for MLS and Sinusoidal measurements.

REFERENCE
Name of the reference file.

SAVEBINARY
=1 saves also in binary format if SAVETEXT=1. Ignored if used alone.
If omitted defaults to 0. Remember that if neither SAVETEXT nor SAVEBINARY are specified the default format is binary.

SAVENAME Name of the file to be saved.

SAVEONBAD
=1 automatically saves the current measurement if bad.
=0 Not active. If omitted defaults to 0.
Refer also to AUTOSAVE.

SAVEONGOOD
=1 Autosaves the current measurements, if result is good.
=0 Does not perform autosave. If omitted defaults to 0.

If you want to autosave also in case of bad measurement add the keyword SAVEONBAD=1.

SAVEPROMPT

=1 Prompts the user for file name input.
=0 Autosaves without prompting.
If omitted defaults to 0.

SAVETEXT =1 saves ASCII file instead of binary format.
=0 saves files with normal binary format. If omitted defaults to 0.

SAVETEXTPARAM

Controls the kind of exported data.

For MLS

=0 Display Frequency Data.
=1 FFT Frequency Data.
=2 Time Data.

For FFT

=0 Display Frequency Data.
=1 FFT Frequency Data.
=2 Last FFT Data.
=3 Last Time Data.

For Sinusoidal

=0 Frequency Data.
=1 Frequency + Distortion Data.

SAVETEXTPARAM2

Controls the number of saved frequency points (valid only for MLS)

=0 saves 256 points.
=1 saves 512 points.
=2 saves 1024 points.
=3 saves 2048 points.
If omitted defaults to 0, i.e. 256 points.

20.4.3 KEYWORDS FOR AUXILIARY TESTS AND MATH OPERATION

- [AUX]** Starts a section containing the definition of an auxiliary test or a math operation.
- TEST** It can be the kind of math operation to be chosen among the following:
SUM n
DIFFERENCE n
MULTIPLICATION n
DIVISION n (where n denotes the relative operands number (see 19.11.2);
 n may range from 0 to 9.)
Or it can be a value read by QCBox Model5:
QCBOXINBIT0
QCBOXINBIT1
QCBOXINBIT2
QCBOXINBIT3
QCBOXINBIT4
QCBOXINBYTE
QCBOXINDC3
QCBOXINDC4
QCBOXOUTCURRENT
- LOWER** Lower limit for the math operation check.
- UPPER** Upper limit for the math operation check.
- QCBOXINBITVALUE**
Value of the input bit to be checked.
- QCBOXINBYTEVALUE**
Value of the input byte to be checked.

20.4.4 KEYWORDS FOR CONDITIONAL EXECUTION

[PERFORM]

Starts a section which is always executed, unaffected by the result of the preceding measurement. See below for the keywords possible within.

[IF LAST GOOD]

[IF LAST BAD]

Starts a section conditioned by the result of the preceding measurement.

[IF *..parameter..* GOOD]

[IF *..parameter..* BAD]

Starts a section conditioned by the result of one particular parameter measured during the preceding measurement.

..parameter.. can be one of the following:

LEVEL	(MLS,sinusoidal,FFT)
SENSITIVITY	(MLS,sinusoidal,FFT)
RESPONSE	(MLS,sinusoidal,FFT)
POLARITY	(MLS,sinusoidal)
A/B	(sinusoidal)
RUB+BUZZ	(sinusoidal)
TOTAL HARMONIC	(sinusoidal)
2 HARMONIC	(sinusoidal)
3 HARMONIC	(sinusoidal)
4 HARMONIC	(sinusoidal)
5 HARMONIC	(sinusoidal)
6 HARMONIC	(sinusoidal)
7 HARMONIC	(sinusoidal)
8 HARMONIC	(sinusoidal)
9 HARMONIC	(sinusoidal)
10 HARMONIC	(sinusoidal)
FS	(T&S)
QTS	(T&S)
QES	(T&S)
QMS	(T&S)
VAS	(T&S)
BL	(T&S)
MMD	(T&S)
MMS	(T&S)
DBSPL	(T&S)
ZMIN	(T&S)
RLR	(MLS,sinusoidal)
SLR	(MLS,sinusoidal)
STMR	(MLS,sinusoidal)
FREQUENCY	(multimeter)
IMD	(multimeter)
PRESSURE	(multimeter)
THD	(multimeter)
VOLTAGE	(multimeter)

[IF ALL GOOD]

[IF ALL BAD]

Starts a section conditioned by the global result of the QC sequence.

Note: The following keywords apply to any kind of section for conditional execution.

- BIT** Number of the bit to be singularly controlled with "BITVALUE".
- BITVALUE** Status (=1 or =0) of the bit defined with "BIT".
- 8BITVALUE** 8-BIT decimal value to be output by the currently selected parallel port.
- ABORT** Stops the script execution after executing all keywords in the current section. Result is forced bad. See also STOP.
- CLOSESERIAL** Closes the QC COM port after serial communication.
- DELAY** Value in milliseconds of a pause to be performed.
- EXPORTGRAPHICS** Exports the current measurement to a graphical file. The same file naming convention used for data files is used.
- EXTERNAL** Name of an executable file to be launched. See also PARAMETERS and WAITCOMPLETION.
- IN** Sets the input sensitivity for both input channels.
- INA** Sets channel A input sensitivity; channel B sensitivity remains untouched.
- INB** Sets channel B input sensitivity; channel A sensitivity remains untouched.
- MESSAGE** Text to be displayed in a prompting message to the user.
- MESSAGE2** Second line of text to be displayed in a prompting message to the user.
- MESSAGE3** Third line of text to be displayed in a prompting message to the user.
- MESSAGE4** Fourth line of text to be displayed in a prompting message to the user.
- OPENSERIAL** Opens the QC COM port for serial communication. See 6.3.6 for RS-232 settings.
- OUT** Sets the generator output level (with OUTUNITS defined under [GLOBALS]).
- OUTQCBOS** Sets the generator output level taking into account QCBox gain (with OUTUNITS defined under [GLOBALS]). This is the level that will be present at QCBox output.
- PARAMETER1** String to be passed, as first parameter, to the executable defined with "EXTERNAL". Some parameters relative to the QC tests can be passed with the following acronyms:
@SERIALNUMBER passes the current serial number.
@RESULT passes the current result.

@LASTRESULT passes the last test result.
@GLOBALRESULT passes the global test result.

PARAMETER2

String to be passed, as second parameter, to the executable defined with "EXTERNAL". See also PARAMETER1 above.

PARAMETER3

String to be passed, as third parameter, to the executable defined with "EXTERNAL". See also PARAMETER1 above.

PARAMETER4

String to be passed, as fourth parameter, to the executable defined with "EXTERNAL". See also PARAMETER1 above.

PICTURETITLE

Name of the window where the image loaded with SHOWPICTURE.

PRINT Prints the current measurement. The default Windows printer is used.

QCBOXCURRENTLIMIT

Current limit (A) for Model 5 operation. Ranges from 0 to 10.

QCBOXDCOUT

DC voltage (V) to be output by Model 5 superimposed to generated signal. Ranges from -20 to 20.

QCBOXINITIALBYTE

8-BIT binary value that will be output from Model 5 port at startup before QC script execution.

QCBOXOUTBIT0

Status (=1 or =0) of the bit that will be output from Model 5 BIT0.

QCBOXOUTBIT1

Status (=1 or =0) of the bit that will be output from Model 5 BIT1.

QCBOXOUTBIT2

Status (=1 or =0) of the bit that will be output from Model 5 BIT2.

QCBOXOUTBIT3

Status (=1 or =0) of the bit that will be output from Model 5 BIT3.

QCBOXOUTBIT4

Status (=1 or =0) of the bit that will be output from Model 5 BIT4.

QCBOXOUTBIT5

Status (=1 or =0) of the bit that will be output from Model 5 BIT5.

QCBOXOUTBYTE

8-BIT binary value that will be output from Model 5 port.

QCBOXPHANTOM

Microphone power supply voltage (V) set for Model 5 IN1 and IN2 input. Ranges from 2 to 24.

SERIALOUT

ASCII text to be sent to serial device.

You may use some acronyms preceded by @:

@SERIALNUMBER is translated in the current serial number

@DATE is translated in the current date

@TIME is translated in the current time

SERIALOUTFILE

Name of an ASCII file containing text to be sent to serial device.

SERIALOUTCR

=1 Outputs carriage returns at the end of serial data.

=0 Does not output carriage returns at the end of serial data.

Defaults to 0.

SHOWPICTURE

Name of an image file containing a picture to be output to screen. See also PICTURETITLE.

STOP

Stops the script execution after executing all keywords in the current section. Result is unaltered. See also ABORT.

WAITCOMPLETION

=1 The QC script wait for the external program to end before continuing execution.

=0 The QC sequence continue without waiting. If omitted defaults to 0.

20.4.5 KEYWORDS FOR HARDWARE CONTROL

[RESETLOOPA]

Opens internal loop on channel A. Valid only for CLIO running PB-4281 PCI card and SC-01 signal conditioner.

[RESETLOOPB]

Opens internal loop on channel B. Valid only for CLIO running PB-4281 PCI card and SC-01 signal conditioner.

[RESETMUTEA]

Switches mute for channel A off.

[RESETMUTEB]

Switches mute for channel B off.

[RESETPHANTOM]

Switches phantom power off.

[RESETPHANTOMA]

Switches phantom power for channel A off.

[RESETPHANTOMB]

Switches phantom power for channel B off.

[SETIMPEDANCE]

Selects impedance mode of the CLIOQC Amplifier & SwitchBox.

[SETINPUT1]

[SETINPUT2]

[SETINPUT3]

[SETINPUT4]

[SETINPUT5]

[SETINPUT6]

[SETINPUT7]

[SETINPUT8]

Selects the relative input channel of the CLIOQC Amplifier & SwitchBox.

[SETISENSE]

Selects isense mode of the CLIOQC Amplifier & SwitchBox.

[SETLOOPA]

Closes internal loop on channel A. Valid only for CLIO running PB-4281 PCI card and SC-01 signal conditioner.

[SETLOOPB]

Closes internal loop on channel B. Valid only for CLIO running PB-4281 PCI card and SC-01 signal conditioner.

[SETMUTEA]

Switches mute for channel A on.

[SETMUTEB]

Switches mute for channel B on.

[SETPHANTOM]

Switches phantom power on.

[SETPHANTOMA]

Switches phantom power for channel A on.

[SETPHANTOMB]

Switches phantom power for channel B on.

20.4.6 OTHER KEYWORDS**[SNINPUT]**

Prompts the user for serial number input.

[STOP] Immediately stops the script execution.

20.4.7 KEYWORDS USED IN LIMITS FILES

[ABSOLUTE]

Defines an absolute limit file. This is also the default condition when the [RELATIVE] keyword is not specified.

[FLOATING]

If present forces floating limits curves.

[RELATIVE]

Defines a relative limit file.

PERCENT =1 Interprets limit curves values as percentages.
=0 Does not interpret limit curves values as percentages.
Defaults to 0.

FREQJITTER

Value, expressed in fractions of octave, used to calculate the relative limit curve. It is useful to correct false negatives given by steep reference curve behaviour.

[LEVEL] Starts a section defining a check on the mean level of the measured curve.

ALIGNFREQ

Align frequency for the mean level check. Valid only when ALIGNLEV is specified and it is not ALIGNLEV=REFERENCE. See below.

ALIGNLEV Align level for the mean level check. If it is specified as "ALIGNLEV=REFERENCE" then the mean level check is against the average level of the reference in the band defined by the frequency mask used for the response check. If omitted defaults to ALIGNLEV=REFERENCE.

LOWER Lower limit for the mean level check.

UPPER Upper limit for the mean level check.

FREQLO Lower frequency to calculate the mean level. If omitted the lower frequency is taken from the lowest frequency defined by the frequency mask.

FREQHI Upper frequency to calculate the mean level. If omitted the upper frequency is taken from the highest frequency defined by the frequency mask.

[SENSITIVITY]

Starts a section defining a check on the sensitivity of the measured curve.

LOWER Lower limit for the sensitivity check.

UPPER Upper limit for the sensitivity check.

FREQ1..FREQ8

Define up to eight frequencies where to calculate and then average sensitivity. If omitted the sensitivity is calculated averaging the band defined by the extremes of the frequency mask.

[TSPARAMETERS]

Starts a section defining a Thiele&Small parameters check.

- PERCENT =1 Interprets limit values as percentages.
 =0 Does not interpret limit values as percentages.
 Defaults to 0.
- REDC Value (in Ohms) to be input representing the DC resistance of the voice coil.
 REDC must **always** be specified.
- DIAMETER Input value (in mm) specifying the driver diameter. It is needed **only** when testing Cms, Mms, Mmd, Bl, Vas, dBSPL or ZMin; used with one of the fixed parameters: KNOWNMMD or KNOWNMMS or KNOWNCMS. **You must specify only one fixed parameter.**
- KNOWNMMD
 Input value for the fixed Mmd parameter. It is needed **only** when testing Cms, Mms, Mmd, Bl, Vas, dBSPL or ZMin.
- KNOWNMMS
 Input value for the fixed Mms parameter. It is needed **only** when testing Cms, Mms, Mmd, Bl, Vas, dBSPL or ZMin.
- KNOWNCMS
 Input value for the fixed Cms parameter. It is needed **only** when testing Cms, Mms, Mmd, Bl, Vas, dBSPL or ZMin.
- FSLOWER Lower limit for Fs.
- FSUPPER Upper limit for Fs.
- QELOWER Lower limit for Qes.
- QEUPPER Upper limit for Qes.
- QMLOWER Lower limit for Qms.
- QMUPPER Upper limit for Qms.
- QTLLOWER Lower limit for Qts.
- QTUPPER Upper limit for Qts.
- CMSLOWER
 Lower limit for Cms.
- CMSUPPER
 Upper limit for Cms.
- MMSLOWER
 Lower limit for Mms.
- MMSUPPER
 Upper limit for Mms.
- MMDLOWER
 Lower limit for Mmd.
- MMDUPPER
 Upper limit for Mmd.

BLOWER Lower limit for BI.

BLUPPER Upper limit for BI.

VASLOWER
Lower limit for Vas.

VASUPPER
Upper limit for Vas.

DBSPLLOWER
Lower limit for dBSPL.

DBSPLUPPER
Upper limit for dBSPL.

ZMINLOWER
Lower limit for ZMin.

ZMINUPPER
Upper limit for ZMin.

[LR]
Starts a section defining a loudness rating check.

PERCENT =1 Interprets limit values as percentages.
=0 Does not interpret limit values as percentages.
Defaults to 0.

RLRLOWER Lower limit for RLR.

RLRUPPER Upper limit for RLR.

SLRLOWER Lower limit for SLR.

SLRUPPER Upper limit for SLR.

STMRLOWER
Lower limit for STMR.

STMRUPPER
Upper limit for STMR.

[UPPER LIMIT DATA]

[LOWER LIMIT DATA]

Start a section containing the frequency mask used for the QC check. The frequency mask has to be defined as a list of N couples like:

Frequency_1 Value_1

.....

.....

Frequency_N Value_N

In the case of a multimeter measurement containing several measured parameters value.

It is possible to load frequency data from an external ASCII text file using the FILE keyword.

- FILE Name of a text file containing a frequency mask definition.
- FREQUENCY Executes a frequency check. Valid for a multimeter measurement.
- IMD Executes an intermodulation distortion check. Valid for a multimeter measurement.
- PRESSURE Executes a sound pressure level check. Valid for a multimeter measurement.
- THD Executes a total harmonic distortion check. Valid for a multimeter measurement.
- VOLTAGE Executes a voltage check. Valid for a multimeter measurement.

[A/B UPPER LIMIT DATA]

[A/B LOWER LIMIT DATA]

[RUB+BUZZ UPPER LIMIT DATA]

[RUB+BUZZ LOWER LIMIT DATA]

[THD UPPER LIMIT DATA]

[THD LOWER LIMIT DATA]

[*n* UPPER LIMIT DATA]

[*n* LOWER LIMIT DATA]

n may range from 2 (2nd harmonic) to 10 (10th harmonic).
Start a section containing the frequency mask used for the QC check of the following calculated curves within a sinusoidal sweep.
The presence of the relative section defines the QC check.
The frequency mask has to be defined as a list of N couples like:

Frequency_1	Value_1
.....	
.....	
Frequency_N	Value_N

It is possible to load frequency data from an external ASCII text file using the FILE keyword.

- FILE Name of a text file containing a frequency mask definition.

[A/B DISPLAY]

[RUB+BUZZ DISPLAY]

[THD DISPLAY]

[*n* HARMONIC DISPLAY]

n may range from 2 (2nd harmonic) to 10 (10th harmonic).

Defines which curve of the calculated ones will be displayed. it is possible to display only one curve.

[REFERENCE DATA]

Start a section containing the frequency response used as reference; if present substitute data taken from the reference file (as defined in 19.3). The frequency mask has to be defined as a list of N couples like:

```
Frequency_1    Value_1  
.....  
.....  
Frequency_N    Value_N
```

It is possible to load frequency data from an external ASCII text file using the FILE keyword.

FILE Name of a text file containing a frequency mask definition.

BIBLIOGRAPHY

- [1] Joseph D'Appolito, "Testing Loudspeakers", Audio Amateur Press, 1998.
- [2] J.M. Berman and L.R. Fincham, "The Application of Digital Techniques to the Measurement of Loudspeakers", J. Audio Eng. Soc., Vol. 25, 1977 June.
- [3] L.R. Fincham, "Refinements in the Impulse Testing of Loudspeakers", J. Audio Eng. Soc., Vol. 33, 1985 March.
- [4] S.P. Lipshitz, T.C. Scott and J. Vanderkooy, "Increasing the Audio Measurement Capability of FFT Analyzers by Microcomputer Postprocessing", J. Audio Eng. Soc., Vol. 33, 1985 September.
- [5] D.D. Rife and J. Vanderkooy, "Transfer Function Measurement with Maximum-Length Sequences", J. Audio Eng. Soc., Vol. 37, 1989 June.
- [6] A. Duncan, "The Analytic Impulse", J. Audio Eng. Soc., Vol. 36, 1988 May.
- [7] J. Vanderkooy and S.P. Lipshitz, "Uses and Abuses of the Energy-Time Curve", J. Audio Eng. Soc., Vol. 38, 1990 November.
- [8] G. Ballou, "Handbook for Sound Engineers – The New Audio Cyclopedia", Howard W. Sams & Company, 1987.
- [9] D. Davis and C. Davis, "Sound System Engineering", Howard W. Sams & Company, 1987.
- [10] R.H. Small, "Simplified Loudspeaker Measurements at Low Frequencies", J. Audio Eng. Soc., 1972 Jan/Feb.
- [11] D.B. Keele Jr, "Low Frequency Loudspeaker Assessment by Near-field Sound Pressure Measurements", J. Audio Eng. Soc., 1974 April.
- [12] W.D.T. Davies, "Generation and properties of maximum length sequences", Control, 1966 June/July/August.
- [13] F.J. MacWilliams and N.J.A. Sloane, "Pseudo-random sequences and arrays", Proc. IEEE, 1976 December.
- [14] M.R. Schroeder, "Integrated impulse method measuring sound decay without using impulses", J. Acoust. Soc. Am., 1979 August.
- [15] J. Borish and J.B. Angell, "An efficient algorithm for measuring the impulse response using pseudorandom noise", J. Audio Eng. Soc., 1983 July/August.
- [16] D.D. Rife, "Maximum length sequences optimize PC-based linear system analysis", Pers. Eng. Inst. News, 1987 May.
- [17] C. Dunn and M.O. Hawksford, "Distortion Immunity of MLS-Derived Impulse Response Measurements", J. Audio Eng. Soc., 1993 May.
- [18] R.H. Small, "Direct-Radiator Loudspeaker System Analysis", J. Audio Eng. Soc., 1972 June.
- [19] M.O. Hawksford, "Digital Signal Processing Tools for Loudspeaker Evaluation and Discrete-Time Crossover Design", J. Audio Eng. Soc., 1997 January/February.

- [20] D. Clarke, "Precision Measurement of Loudspeaker Parameters", J. Audio Eng. Soc., 1997 March.
- [21] IASCA - International Auto Sound Challenge Association Inc. - "Official Judging Rules".
- [22] A. Farina, "Simultaneous measurements of impulse response and distortion with a swept sine technique", AES Preprint n.5093, 108th Convention, 2000 February.
- [23] S. Mueller and P. Massarini, "Transfer function measurement with sweeps", J. Audio Eng. Soc., 2001 June.
- [24] T. Kite, "Measurements of audio equipment with log-swept sine chirps", AES Preprint n.6269, 117th Convention, 2004 October.
- [25] S. J. Loutridis, "Decomposition of Impulse Responses Using Complex Wavelets", JAES, Vol. 53, No. 9, 2005 September
- [26] D. B. Keele, "Time-Frequency Display of Electroacoustic Data Using Cycle-Octave Wavelet Transforms," 99th Convention AES, preprint 4136.
- [27] A. Mertins, "Signal Analysis: Wavelets, Filter Banks, Time-Frequency Transforms and Applications", 1999 J. Wiley.

NORMS

- [1] IEC 61672, Sound Level Meters (replacing former IEC 651, Sound level meters and IEC 804, Integrating-averaging sound level meters).
- [2] IEC 60268, Sound system equipment.
- [3] IEC 60386, Methods of measurement of speed fluctuations in sound recording and reproducing equipment.
- [4] ISO 226, Normal equal-loudness-level contours.
- [5] ISO 266, Preferred frequencies for measurements.
- [6] ISO 3382, Measurement of reverberation time of rooms with reference to other acoustical parameters.
- [7] IEC 61260, Octave-band and fractional-octave-band filters.
- [8] SMPTE RP120, Measurement of Intermodulation Distortion in Motion-Picture Audio Systems.

