

NC400 Definitive performance class D amp for DIY

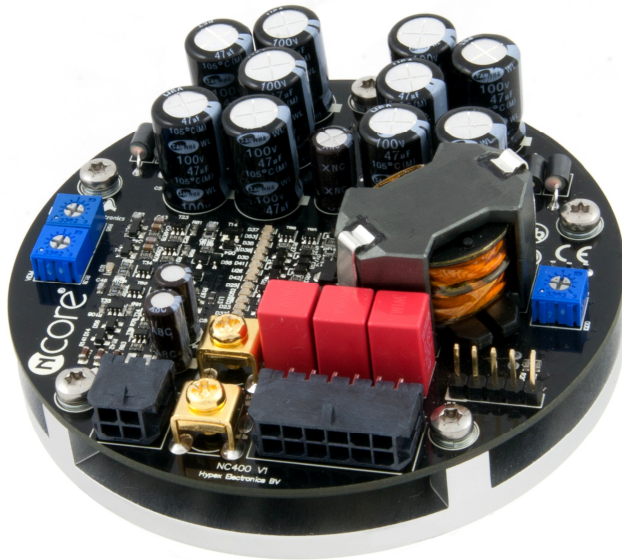

Highlights

- Unprecedentedly low distortion over frequency and power range
- Unprecedentedly low output impedance
- Very low noise
- Neutral and transparent reproduction: "Neither dirt nor fairy dust"

Features

- Fully discrete signal path – no IC's
- Differential audio input
- Flexible power supply arrangement
- 24A current capability
- Extensive, microprocessor-controlled error protection

Applications

- No-compromise power amp module for audiophile DIY projects
- Active speakers, standalone power amps

Description

The NC400 amplifier module is an extremely high-quality audio power amplifier module which operates in class D. Not only does it offer a way for audiophile music reproduction to continue in an ever more energy-conscious world, its measured and sonic performance actually raises the bar for audio amplifiers of any description. Operation is based on a non-hysteresis 5th order self-oscillating control loop taking feedback only at the speaker output.

Contents

| | |
|--|----|
| Contents | 2 |
| 1 Performance data | 2 |
| 2 Audio Input Characteristics | 3 |
| 3 Control I/O Characteristics | 3 |
| 4 Absolute maximum ratings | 4 |
| 5 Recommended Operating Conditions and Supply Currents | 4 |
| 6 Frequently asked numbers | 5 |
| 7 Connections | 5 |
| 8 Microprocessor functions | 6 |
| 9 Typical performance graphs | 8 |
| 10 Application hints | 9 |
| 11 Drawings | 10 |
| 12 Connection guidelines | 11 |
| 13 Bugs and known issues | 15 |

1 Performance data

Power supply = SMPS600, Load=4Ω, MBW=20kHz, Source imp=40Ω , unless otherwise noted

| Item | Symbol | Min | Typ | Max | Unit | Notes |
|------------------------------------|--------------------------|------|--------|-------|------|---|
| Rated Output Power | P_R | | 580 | | W | THD=1%, Load=2Ω |
| | | | 400 | | W | THD=1%, Load=4Ω |
| | | | 200 | | W | THD=1%, Load=8Ω |
| Distortion | THD+N, IMD ¹⁾ | | 0.0007 | 0.002 | % | 20Hz<f<20kHz ¹⁾ , 4Ω Pout<P _R /2 |
| Output noise | U_N | | 23 | 25 | μV | Unwtd |
| Signal-to-noise ratio (unweighted) | SNR | 124 | 125 | | dB | Re P _R |
| | | 101 | 102 | | | Re 2.8Vrms |
| Output Impedance | Z_{OUT} | | 0.6 | 1 | mΩ | f<16kHz |
| | | | | 2.5 | mΩ | f=20kHz |
| Power Bandwidth | PBW | 35 | | | kHz | ²⁾ |
| Frequency Response | | 0 | | 50 | kHz | +0/-3dB. All loads. |
| Voltage Gain | A_V | 25.3 | 25.8 | 26.3 | dB | |
| Output Offset Voltafe | $ V_{off} $ | | | 50 | mV | |
| Supply Ripple Rejection | PSRR | 75 | 80 | | dB | Either rail, f<1kHz. |
| Efficiency | η | | 93 | | % | Full power |
| Idle Losses | P_o | | 4.5 | 5 | W | External VDR |
| Current Limit | | 23 | 24 | 26 | A | Hiccup mode after 200ms limiting |

Note 1: At higher audio frequencies there are not enough harmonics left in the audio band to make a meaningful THD measurement. High frequency distortion is therefore determined using a 18.5kHz+19.5kHz 1:1 two-tone IMD test.

Note 2: Dielectric losses in the output capacitor limit long term (>30s) full-power bandwidth to 15kHz.

2 Audio Input Characteristics

| Item | Symbol | Min | Typ | Max | Unit | Notes |
|--------------------|-------------|-----|------------|-----|------------|---|
| DM Input Impedance | $Z_{IN,DM}$ | | 104 | | k Ω | |
| CM Input Impedance | $Z_{IN,CM}$ | | 1.5 | | M Ω | |
| CM Rejection Ratio | CMRR | | 55 | | dB | All frequencies |
| Bias current | I_{CM} | | +/- 200 | | nA | Inputs shorted together, sum measured to GND |
| Offset current | I_{DM} | | +/-3 | | nA | |

3 Control I/O Characteristics

| Item | Symbol | Min | Typ | Max | Unit | Notes |
|------------------------------|-------------|------|-----|-----|------------|----------------------|
| Pull-up | R_{WPULL} | | 27 | | k Ω | To 3.3V |
| Logical high input voltage | V_{IH} | 2.65 | | 3.6 | V | nAMPON, SCL, SDA |
| Logical low input voltage | V_{IL} | -0.3 | | 0.5 | V | nAMPON, SCL, SDA |
| Logical high leakage current | I_{OH} | | | 1 | μ A | FATAL |
| Logical low output voltage | V_{OL} | | | 0.4 | V | FATAL, $I_{OL}=1$ mA |

4 Absolute maximum ratings

Correct operation at these limits is not guaranteed. Operation beyond these limits may result in irreversible damage.

| Item | Symbol | Rating | Unit | Notes |
|-----------------------|-------------|--------|------|---|
| Power supply voltage | V_B | +/-75 | V | See section 8.2 |
| VDR supply voltage | V_{DR} | 25 | V | See section 8.2 |
| Peak output current | $I_{OUT,P}$ | 25 | A | Guarded by current limit at 24A |
| Input voltage | V_{IN} | +/-15 | V | Either input referenced to ground |
| Input current | I_{IN} | 10m | A | Logical inputs and buffer inputs |
| Collector voltage | V_{OC} | 35 | V | Open collector outputs when high |
| Collector current | I_{OC} | 2m | A | Open collector outputs when low |
| Air Temperature | T_{AMB} | 65 | °C | Lower improves lifetime |
| Heat-sink temperature | T_{SINK} | 90 | °C | Thermistor limited. User to select heat sink to insure this condition under most adverse use case |

5 Recommended Operating Conditions and Supply Currents

| Item | Symbol | Min | Typ | Max | Unit | Notes |
|---|------------|------|------------------|------------------|------------|---|
| Power supply voltage | V_B | 35 | 64 | 75 | V | Available output power depends on supply voltage |
| Signal stage supply voltage (positive and negative) | V_{SIG} | 16 | | 25 | V | Unit protects when allowable range is exceeded |
| Signal stage supply current | I_{VSIG} | | 40 | | mA | |
| External driver supply voltage | V_{DR} | | 16 | 25 ¹⁾ | V | Below 16V the internal regulator takes over. |
| Drive supply current | I_{DR} | | 70 ²⁾ | | mA | |
| Load impedance | Z_{LOAD} | 1 | | | Ω | |
| Source impedance | Z_{SRC} | | | 1 | k Ω | For rated noise performance, otherwise higher is fine |
| Effective power supply storage capacitance | C_{SUP} | 4700 | | | μ F | Per rail, per attached amplifier. 4 Ω load presumed. ³⁾ |

Note 1: This voltage is not monitored. Either use a floating supply or leave unconnected. Under no circumstance should this pin be connected to GND or to a supply that references ground.

Note 2: This current will either flow through V_{DR} and -HV or through GND and -HV, depending on whether sufficient voltage is available at V_{DR} .

Note 3: The effective power supply storage capacitance of Hypex SMPS is already in excess of 4700uF. Do not add supplementary capacitance.

6 Frequently asked numbers

The following are neither specifications nor indicators of audio performance but fundamental design choices which in combination with the specific circuit topology lead to the performance found in section 0. They do not influence sound quality directly. Commonly expressed creeds that an amplifier's suitability for high quality audio can be read from these numbers (f_{sw} in particular) are ill informed.

| Item | Symbol | Min | Typ | Max | Unit | Notes |
|------------------------|------------|-----|-----|-----|------------|--|
| Switching frequency | f_{sw} | 470 | 480 | 530 | kHz | Idle, see the white paper. |
| MOSFET ON resistance | R_{DSON} | | 36 | 82 | m Ω | Over tolerance and temperature |
| Dead time | t_b | | 30 | | ns | "Soft" dead time. Effective value depends on load current |
| Output coil inductance | L | 9 | 10 | 11 | μ H | Effective output inductance is this number divided by loop gain. |
| Output coil resistance | R_l | | | 3 | m Ω | |
| Output capacitance | C | 1.8 | 2.0 | 2.2 | μ F | |
| Loop gain | A_l | 55 | 56 | 62 | dB | Loop gain peaks at 15kHz and drops back to 56dB at 20kHz. |

7 Connections

7.1 J5, negative and J6, positive loudspeaker outputs

Custom gold-plated screw tags. Insert bare wire between the mobile square nut and the fixed part. The positive output is J6, the one nearest the edge of the circuit board. Note: the output impedance of the NC400 is very low, allowing you to maximize the benefit of biwired configurations by starting both cable runs from the screw tags.

It is very important to use twisted pairs for the output cabling, at the very least anywhere near the PSU cabling. The distortion of the NC400 is so low that it is easily exceeded by magnetic coupling between the supply wiring and the audio wiring.

7.2 J7 Power input and error signal

Connector type: 2x6 pin Molex Microfit header type 43045-1200. Mates with 43025-1200 cable part.

| Pin | Type | Function |
|----------|--------------------|--|
| 1, 2 | Pwr | +HV: unregulated supply (nominally +64V) |
| 3,4,9,10 | Pwr | GND |
| 5 | o/c ⁽¹⁾ | nFATAL: Catastrophic fault indication, inverse of internal FATAL bit. |
| 6 | Pwr in | + V_{SIG+} positive supply for op amps. |
| 7,8 | Pwr in | -HV: unregulated supply (nominally -64V) |
| 11 | Pwr in | V_{DR} optional external driver supply connection. A floating unregulated 16V to 25V supply is connected between this pin and -HV. |
| 12 | Pwr in | - V_{SIG-} negative supply for op amps. |

Note 1: o/c=open collector.

7.3 J9 Audio input

Connector type: 2x2 pin Molex Microfit header type 43045-0412, Mates with 43025-0400 cable part.

| Pin | Type | Function |
|-----|-----------------------|--------------------------------|
| 1 | Analogue in | INH: non-inverting audio input |
| 2 | Analogue in | INC: inverting audio input |
| 3 | in, wpu ¹⁾ | nAMPON |
| 4 | passive | Ground. |

Note 1: wpu=weakly pulled up to 3.3V, not to be driven above 3.3V.

The audio input is differential. This means that ground is not part of the audio signal. When connecting an unbalanced source, treat pins 1 and 2 as a floating input with pin 2 being the “audio ground” of the source. Pin 4 may be used to attach the shield of a shielded twisted pair cable, but the “audio ground” connection of an unbalanced source should never connect here.

8 Microprocessor functions

Important notice: the microprocessor functionality cannot be custom-tailored and should not be tampered with. Source code will not be made available.

8.1 Firmware operation

The microprocessor has three main functions: to provide an interface for controlling the amplifier, to monitor the supply voltages in order to prevent spurious operation during power up/down and to detect error conditions. Most errors clear automatically as soon as the error condition lifts. The exception is a fatal DC fault. When a large DC output is detected, the amplifier first shuts down to be able to differentiate between an actual power stage breakdown and a DC condition caused by DC at the audio input. If the error persists, the FATAL line is asserted (pulled down) to turn the power supply off. If the error goes away the amplifier turns back on.

8.2 Protection limits

| Item | Symbol | Rating | Unit | Notes |
|----------------------------|--------|--------|------|---|
| +/-HV undervoltage | | 35 | V | |
| +/-HV overvoltage | | 75 | V | |
| VDR undervoltage | | 13.5 | V | Internal drive voltage. The VDR regulator makes this error condition unlikely |
| VDR overvoltage | | 16 | V | Idem. |
| Overtemperature | | 95 | °C | |
| Overtemp, lower hysteresis | | 85 | °C | |

8.3 Control

The amplifier has exactly 1 control line: nAMPON (pin 3 of J9). Pulling nAMPON low enables the amplifier as soon as all error conditions have been cleared for at least two seconds.

8.4 Flowchart

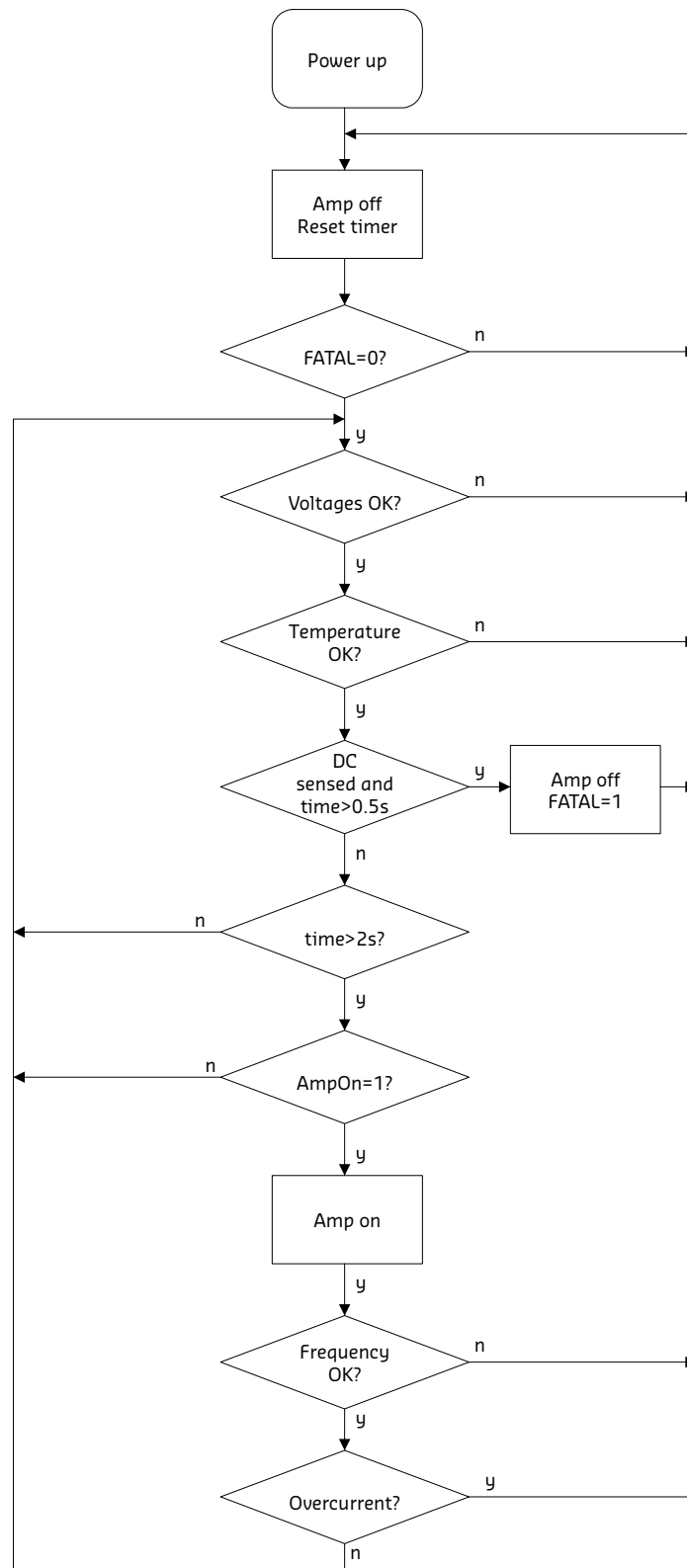

9 Typical performance graphs

Test conditions: one NC400 powered by SMPS600 with 230VAC mains. 4 ohm load except where noted otherwise. Measurement bandwidth=20kHz except for response data.

Note: THD+N includes noise. Noise (mainly thermal noise from resistors) dominates below 10W. Since the noise level is constant and *absolute* its amplitude *relative* to the test signal level, expressed in percents, is higher for lower signal levels. This in no way implies that distortion performance has an optimum at 10W but that at lower powers it is completely unmeasurable amongst the (very low) noise. This is why distortion spectra are only shown for high power levels where any distortion of note exists. "First Watt" performance is, in fact, first rate.

9.1 Small signal tests (all loads)

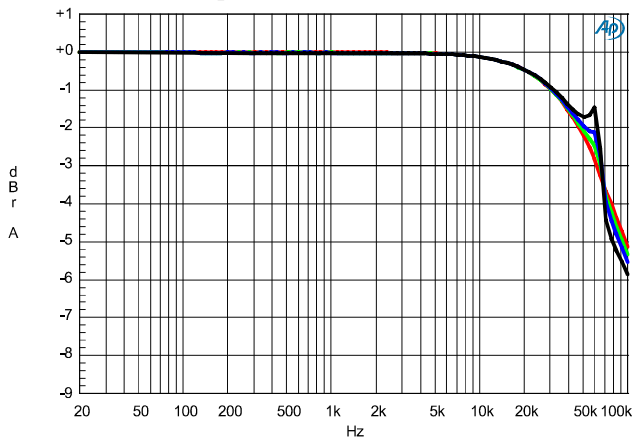

Frequency response into 8 (green), 4 (blue) and 2 (black) ohms and into open circuit (red).

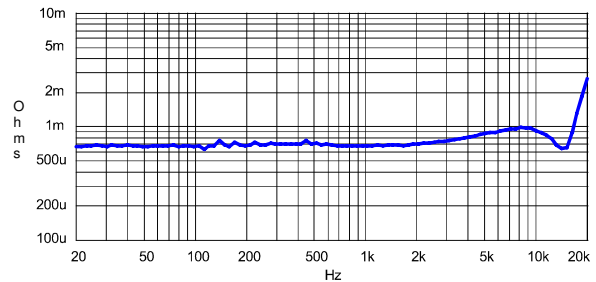

Output impedance, four-wire test at speaker terminals.

9.2 Large signal tests

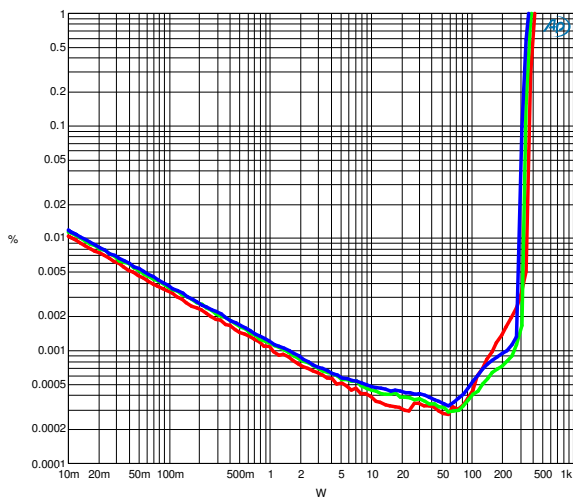

THD+N vs. power at 100Hz (blue), 1kHz (green) and 6kHz (red)

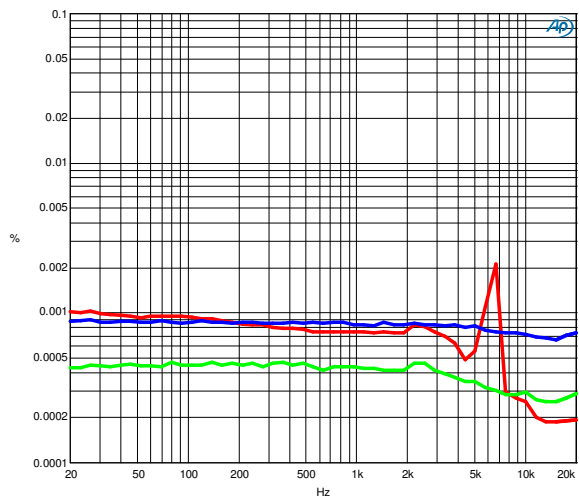

THD vs. frequency at 2W (blue, dominated by noise), 20W (green) and 200W (red)

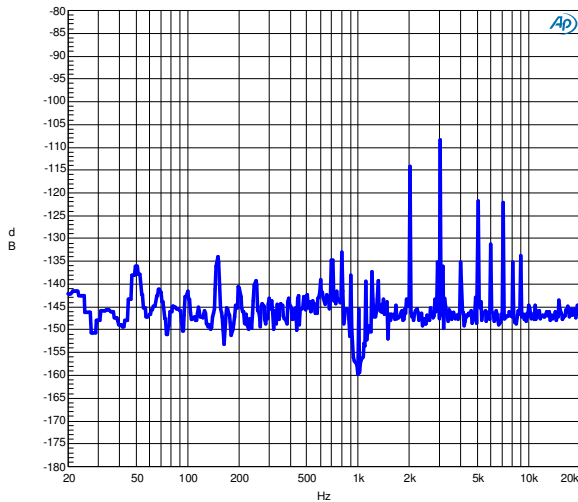

Distortion residual at 200W, 1kHz.

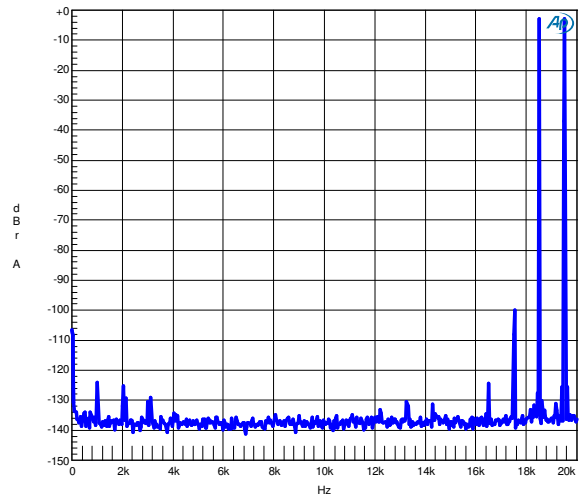

IMD spectrum at 18.5kHz+19.5kHz, 50W+50W. Peak voltage corresponds to a 200W sine.

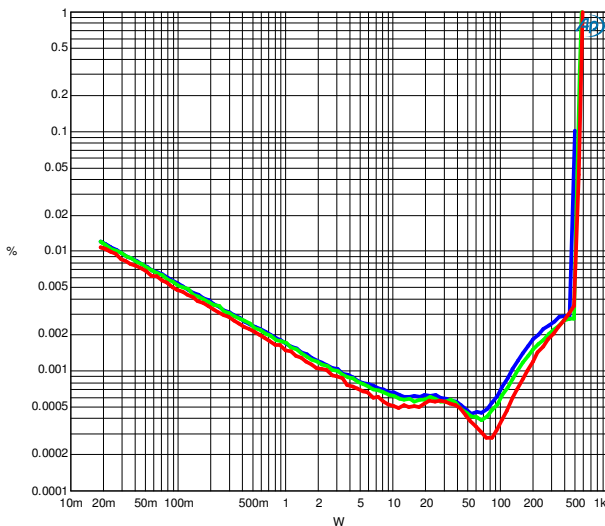

THD+N vs. power into **2 ohms** at 100Hz (blue), 1kHz (green) and 6kHz (red)

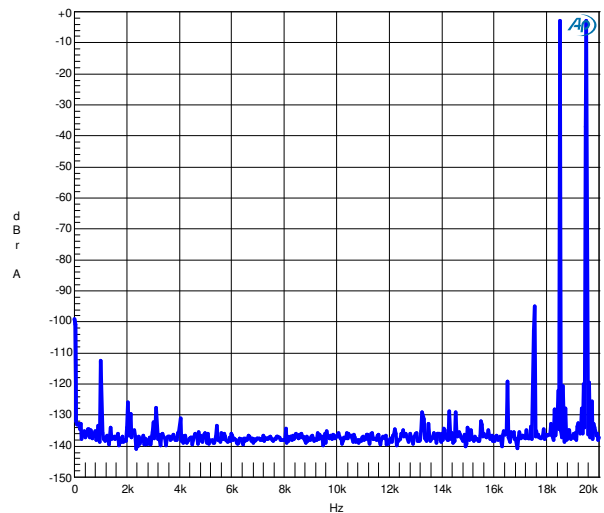

IMD spectrum at 18.5kHz+19.5kHz, 100W+100W into **2 ohms**. Peak voltage corresponds to a 400W sine.

10 Application hints

10.1 Thermal considerations

The amount of cooling needed by the NC400 varies with usage. If your power supply includes a gate drive supply (referenced to -HV), as the SMPS600 does, idle dissipation is around 4.5W. When no drive supply is available, another 5W are being dissipated by the on-board regulator. Additional power loss scales linearly with output power. A good rule of thumb is $P_{loss} = P_{idle} + 0.06 * P_{out}$. How well a cooling arrangement works is expressed as "thermal resistance Θ ". This number indicates how much warmer (in Kelvin or degrees Celsius) the heat sink becomes compared to ambient temperature when asked to dissipate a certain amount (in watts) of thermal power. Thermal resistance is expressed in Kelvin per watt. The lower thermal resistance becomes, the more power you can get rid of for a given allowable temperature rise: $\Delta t = \Theta * P$. A sensible maximum heat sink temperature would be 80°C and a conservative ambient temperature would be a toasty 35°C. Design $\Delta t = 45K$.

More difficult is working out how much average power you need. Music, or even pink noise, has a large peak-to-average ratio so most of the available amplifier power is used as headroom. Audiophile listening is typically carried out at a few watts at most with only the occasional full scale peak. On the other hand, when during a party hyper-compressed modern pop music is turned up until occasional clipping is heard, the average level may well reach 1/3rd of rated output. Nevertheless, agency standards such as EN60065 only call for a continuous power capability of 1/8th of rated output.

This gives us three possible design criteria:

- Normal: Design for 50W continuous output, translating to $P_{loss} = 4.5 + 0.06 * 50 = 7.5W$. Required heatsinking is $\Theta = 45K / 7.5W = 6K/W$.
- Intensive use: Design for 133W. $P_{loss} = 12.5W$, $\Theta = 3.6K/W$.
- Minimal: Design for a few W: $P_{loss} = P_{idle} = 4.5W$. $\Theta = 10K/W$

As it happens, the NC400 without additional cooling has a thermal resistance of around 6K/W. This indicates that free-air cooling is an option in most cases, at least provided that a power supply with driver output is used. It also indicates that any normal metal enclosure will provide enough additional cooling for even very heavy use.

10.2 Bottom-up mounting

Normal mounting proceeds through three tapped holes in the bottom of the plate (marked 1 in the mechanical drawing). Three countersunk M3 screws are included.

10.3 Top-down mounting

Occasionally it may be desirable to bolt the module down from the inside of the chassis into blind tapped holes such as to avoid having any screws visible from the outside. Three of the screws holding the module together are fixed with nuts instead of threaded holes (marked 2 in the mechanical drawing). Remove these three and save them together with the nuts. Replace them by 20mm M3 screws (included) to mount the module.

11 Drawings

11.1 Top view / connector placement

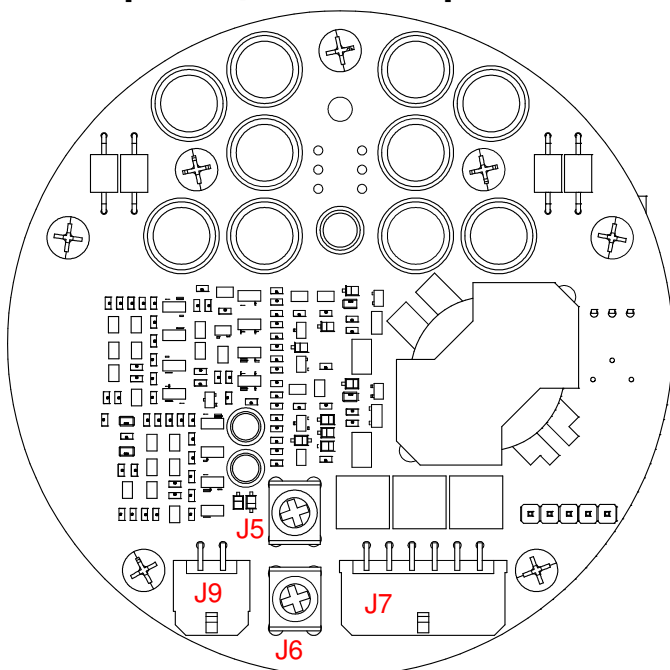

11.2 Front view / pin numbering

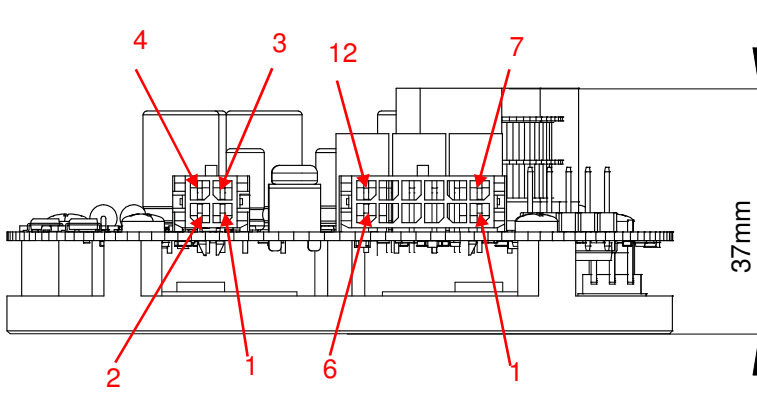

11.3 Bottom view / mounting holes

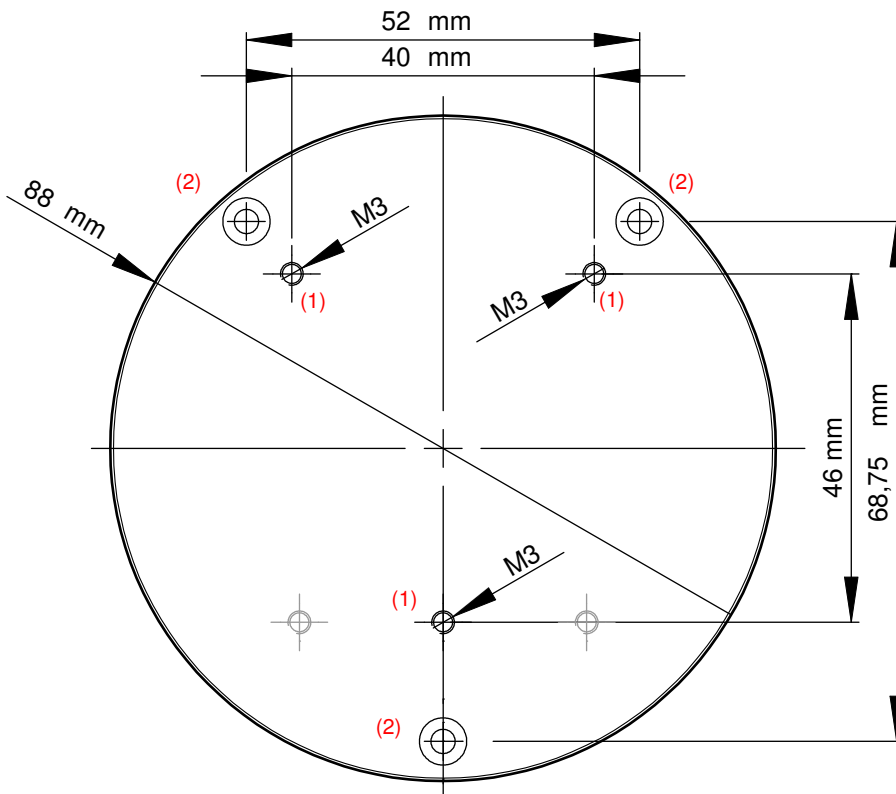

12 Connection guidelines

12.1 Cable dressing

The NC400 module has exceedingly low distortion. This makes it very easy for extraneous causes to add much more distortion and colouration than the amplifier itself. The first major cause of such distortion is direct magnetic crosstalk from the supply cable into the audio input or the loudspeaker output. This is minimized in several ways:

- Run the audio and power supply cables away from each other.
- Tie-wrap the supply cable to form a tight bunch.
- Tightly twist all loudspeaker cabling inside the chassis.

12.2 Input configuration

The second major cause of extraneous noise and distortion is common-impedance coupling between power wiring and signal connections. This is caused by the use of ground-referenced signalling (aka single-ended or unbalanced transmission), which unfortunately is the predominant method of interfacing consumer-grade audio equipment. As a result the ground circuit becomes an inseparable part of the signal path and any currents flowing through the ground circuit affect the audio signal.

Ground loops cannot fundamentally be avoided. Star grounding only works at low frequencies. The longer the wires to the “star”, the lower the frequency at which supply decoupling becomes ineffective. The maximum permissible trace length of decoupling capacitors in class D amplifiers is measured in millimetres and the value of the decoupling capacitances is large. To make a long story short: you cannot connect the audio signal using a single wire and hope to solve the ensuing drama using star grounding. It won’t work.

12.2.1 Way of looking at it when you’re only familiar with unbalanced wiring.

The solution adopted by the NC400 is a floating input, consisting of a “hot” and a “cold” connection, which can be connected to the source like the primary of an isolation transformer. This breaks any current flow that might otherwise flow in the audio cable. You would **never** directly connect the cold pin of the input connector to the ground pin in the same way as you would never locally ground input of an isolation transformer because it would no longer provide isolation.

Note that this isolation is not absolute. Differentials of more than a few 100mV should be avoided. Because of this, some current path should be provided using a third wire. Any current that flows through that wire is current that’s no longer flowing through your audio cable, and which is now harmless.



Figure 1: The basic idea behind a differential (floating) input.

12.2.2 Way of looking at it if you’re used to working with balanced connections.

The NC400 has a balanced input.

12.3 Acceptable wiring schemes for amplifier chassis

The differential input permits a wide range of robust scenarios for hum-free connection, of which three will be shown. We would like to urge users not to venture into the unknown before having tried one of the proven good ones.

12.3.1 Vastly preferred setup: XLR input.

Regardless of whether the remainder of your audio system has balanced connections or not, the very best way to wire the input of the NC400 is to leverage the advantage of its balanced input. You can get almost all of the quality improvement afforded by balanced connections even with an unbalanced source, provided that you have a balanced input.

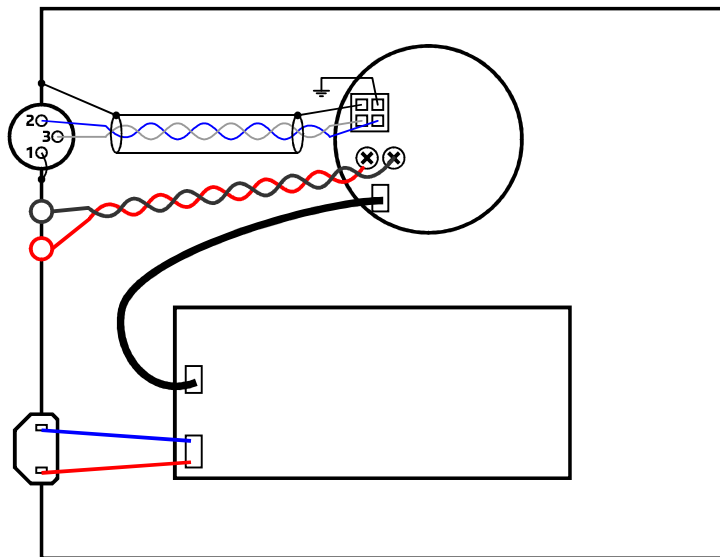

Figure 2: Preferred connection

The input cable included with the module is a high-quality Mogami shielded twisted-pair (microphone) cable. By convention the input connector is a female XLR. How this benefits systems that already use balanced connections is obvious. Importantly though, it benefits unbalanced setups almost equally. This is how it works:

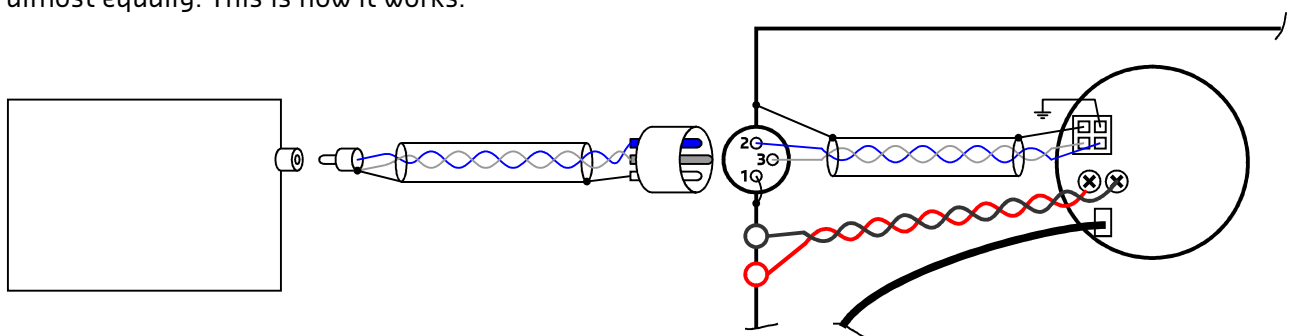

Figure 3: How to benefit from a balanced input even if the source is unbalanced

This is the concept of Figure 1 done in a practical way. A microphone cable is terminated on the source end with an RCA connector and with a male XLR connector on the destination end. The output signal is the voltage difference between the RCA pin and the RCA shell. Since the cold (blue) wire is not used to carry ground currents, the amplifier does indeed see the exact output voltage of the source. Assuming that the RCA shell on the source is bonded to the chassis, we can safely connect the shield wire there as well. The braided cable shield serves two duties: to connect the chassis potentials together and to shield electrostatically the signal.

No safety earth connection was depicted. This is entirely acceptable if class II construction is used throughout. Otherwise, connect the safety earth.

Having made sufficiently clear that there is, in fact, no reason why anyone should ever want to waste a perfectly good balanced input by putting the module in a box with RCA inputs, it is likely that some will persist. Two workable methods are given. The first uses differential wiring up to the rear panel to present a normal unbalanced input to the outside world, the second uses an unbalanced cable as a floating quasi-differential connection.

12.3.2 Acceptable unbalanced setup 1: floating chassis and bonded RCA inputs

The first working method is the simplest. Use class II construction and use a 2-prong mains inlet. Use **uninsulated** RCA connectors and wire it to the NC400 input using the supplied cable using the two-wire-plus-shield method previously used for the RCA-XLR adapter cable. For clarity, a stereo system is shown. Important: place the 2 RCA connectors close together (25mm or so) and once again, bond them solidly to the chassis. What this arrangement does is prevent circulating currents

from getting out into the two connected audio cables. Inside the chassis those currents do no harm because they do not flow through the audio wires.

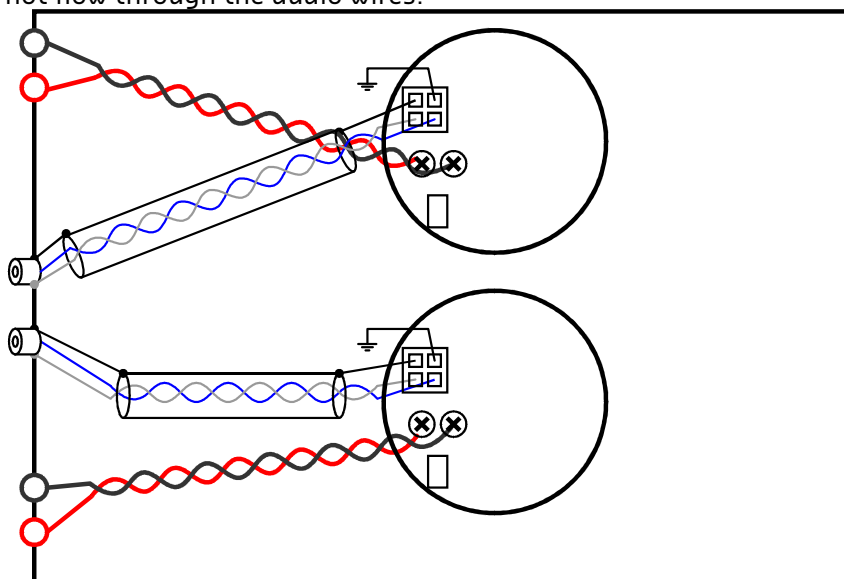

Figure 4: Unbalanced input with hard-bonded RCA's and no mains earth

12.3.3 Acceptable unbalanced setup 2: grounded chassis and semi-floating RCA inputs

Most hum problems are found in systems that use both mains earth and unbalanced inputs. A common workaround is lifting the secondary ground. In some cases this invites hum through capacitive coupling. And in the case of the NC400, short of insulating the whole module the secondary ground cannot be lifted from the chassis. A much better solution is to lift only the input, which you can do when you have an actual difference amplifier at your disposal. The allowable common mode range is not infinite though, so the RCA ground cannot be fully floated. Nevertheless, the added noise rejection when interfacing with other grounded unbalanced kit is substantial.

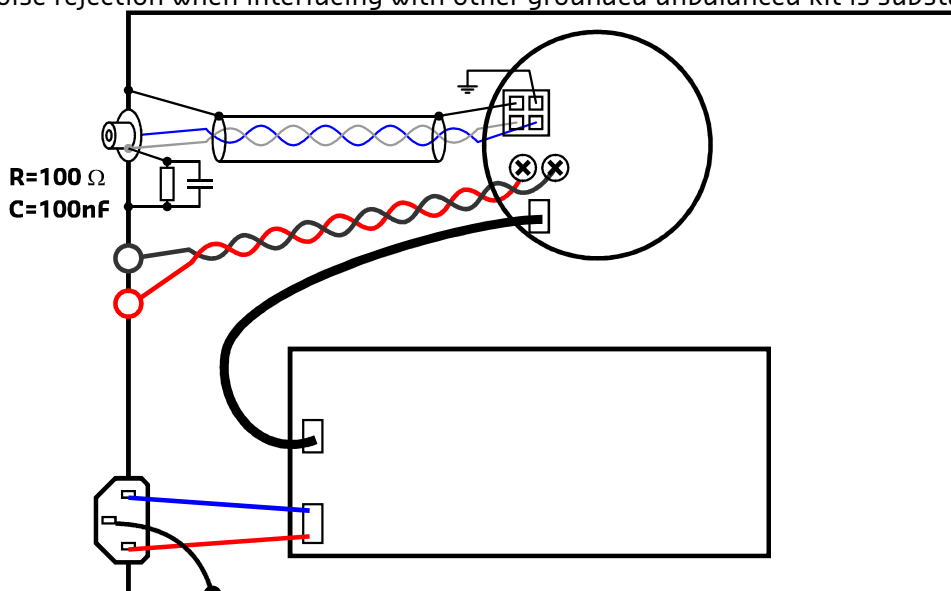

Figure 5: Solution if both mains earthing and RCA inputs are wanted

It should be stressed that the problems concerning unbalanced connections that were outlined here are not related to the amplifier, but are inherent to the very phenomenon of unbalanced connections. The reason why they are being highlighted is precisely because thanks to the presence of a differential input, they can be solved without having to resort to esoteric grounding arrangements.

13 Bugs and known issues

| Bug | Workaround |
|---|---|
| Gain setting resistor is not marked. | It is R141, the resistor furthest to the left of the input connector. |
| Hot/cold speaker terminals are not marked. | The hot (+) terminal is the one closest to the edge of the board. |
| Input bias current may cause a small DC offset when wired according to 12.3.2 or 12.3.3 and no source is connected. | Strap 47k across the RCA input to provide DC path. |

DISCLAIMER: This subassembly is designed for use in music reproduction equipment only. No representations are made as to fitness for other uses. Except where noted otherwise any specifications given pertain to this subassembly only. Responsibility for verifying the performance, safety, reliability and compliance with legal standards of end products using this subassembly falls to the manufacturer of said end product.

LIFE SUPPORT POLICY: Use of Hypex products in life support equipment or equipment whose failure can reasonably be expected to result in injury or death is not permitted except by explicit written consent from Hypex Electronics BV.

| Document Revision | PCB Version | Description | Date |
|--------------------------|--------------------|--|-------------|
| R0 | NC400 V1 | Draft/Preliminary | 19.12.2011 |
| R1 | NC400 V1 | Added wiring instructions, removed the "preliminary" tag | 20.12.2011 |
| R2 | NC400 V1 | Expanded firmware section. Added offset voltage spec. | 5.01.2012 |
| R3 | NC400 V1 | Fixed labeling error on THD vs F graph | 13.01.2012 |
| R4 | NC400 V3 | Signal cable colours changed to match new cable type | 27.07.2012 |
| R5 | NC400 V4 | Format changed Drawings updated | 16.01.2013 |