

The D3305Ti DPD® model is an ultra high quality compression driver for professional use wherever high SPL and low distortion are of great concern.

Pure titanium specially designed diaphragm with IPE® (Impregnated Polymer Fiber) surround, for high sensitivity, low distortion and smooth extended frequency response applications.

The D3305Ti DPD® is recommended for use in arenas, stage monitors, side fills and sound reinforcement systems.

Optimized aluminum injected phase plug avoids phase cancellation problems.

High flux density magnetic assembly.

Protection circuit DPD® (Driver Protection Device). This circuit uses a PTC and a HPCCR resistor assuring more reliability under overload condition.

The flat wire voice coil (copper clad aluminum) uses a high temperature Kapton® former.

Precisely engineered diaphragm structure and alignment mechanism allow for easy, reliable and cost effective repair in case of diaphragm failure.

In the rare case a repair (model RPD3300Ti) may be necessary, please read carefully the instructions supplied and be sure to correctly follow the items step by step.

With a 2" exit throat and standard bolt pattern, it directly couples to Selenium horns with (50 mm) throats.



SPECIFICATIONS

| | | |
|--|---------------|----------|
| Nominal impedance | 8 | Ω |
| Minimum impedance @ 1,900 Hz | 6.7 | Ω |
| Power handling | | |
| Musical Program (w/ xover 800 Hz 12 dB / oct) ¹ | 150 | W |
| Sensitivity | | |
| On horn, 2.83V@1m, on axis ² | 108 | dB SPL |
| On plane-wave tube, 0.0894V ³ | 116 | dB SPL |
| Frequency response @ -10 dB | 500 to 20,000 | Hz |
| Throat diameter | 50 (2) | mm (in) |
| Diaphragm material | | Titanium |
| Voice coil diameter | 75 (3) | mm (in) |
| Re | 4.8 | Ω |
| Flux density | 1.68 | T |
| Minimum recommended crossover (12 dB / oct) | 800 | Hz |

¹ Power handling specifications refer to normal speech and/or music program material, reproduced by an amplifier producing no more than 5% distortion. Power is calculated as true RMS voltage squared divided by the nominal impedance of the loudspeaker. This voltage is measured at the input of the recommended passive crossover when placed between the power amplifier and loudspeaker.
Musical Program = 2 x W RMS.

² Measured with HL14-50 horn, 2,000 - 17,000 Hz average.

³ The sensitivity represents the SPL in a 25 mm terminated tube, 800 - 3,000 Hz average.

ADDITIONAL INFORMATION

| | |
|--|--|
| Magnet material | Barium ferrite |
| Magnet weight | 1,600 (57) g (oz) |
| Magnet diameter x depth | 169 x 19 (6.65 x 0.75) mm (in) |
| Magnetic assembly weight | 4,520 (9.97) g (lb) |
| Housing material | Plastic |
| Housing finish | Black |
| Magnetic assembly steel finish | Zinc-plated |
| Voice coil material | Flat CCAW |
| Voice coil former material | Polyimide (Kapton®) |
| Voice coil winding length | 4.7 (15.4) m (ft) |
| Voice coil winding depth | 2.0 (0.08) mm (in) |
| Wire temperature coefficient of resistance (α25) | 0.00404 1/°C |
| Volume displaced by driver | 1.48 (0.052) l (ft³) |
| Net weight | 4,740 (10.45) g (lb) |
| Gross weight | 5,020 (11.07) g (lb) |
| Carton dimensions (W x D x H) | 20.5 x 20.5 x 11.5 (8 x 8 x 4.5) cm (in) |

MOUNTING INFORMATION

| | |
|-------------------------|--|
| Horn connection | Bolt on |
| Number of holes | 4 (M6) equally spaced threaded holes |
| Threaded holes diameter | 102 (4) mm (in) |
| Connectors | Push terminals |
| Polarity | Positive voltage applied to the positive terminal (red) gives diaphragm motion toward the throat |

DRIVER x HORN CONNECTION

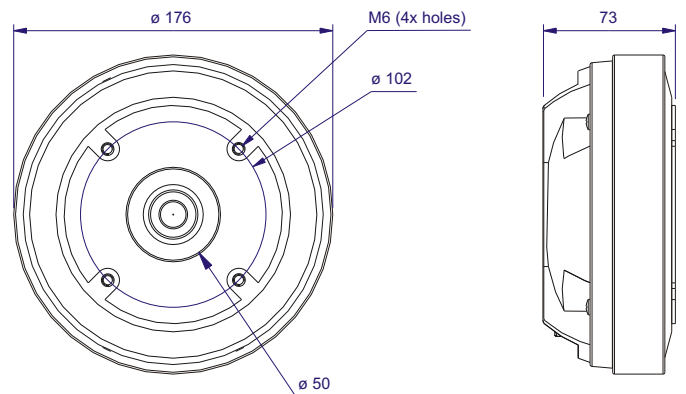
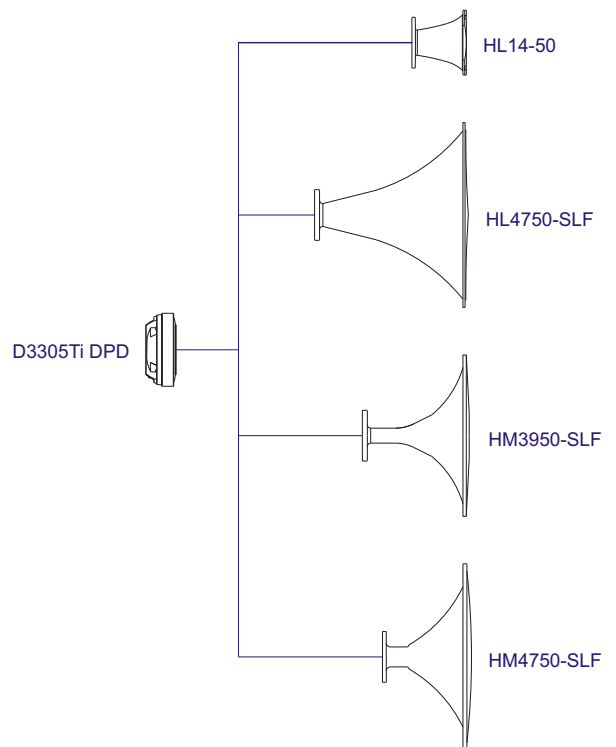

Dimensions in mm.

RESPONSE AND IMPEDANCE CURVES W/ HL14-50 HORN INSIDE AN ANECHOIC CHAMBER, 1 W / 1 m

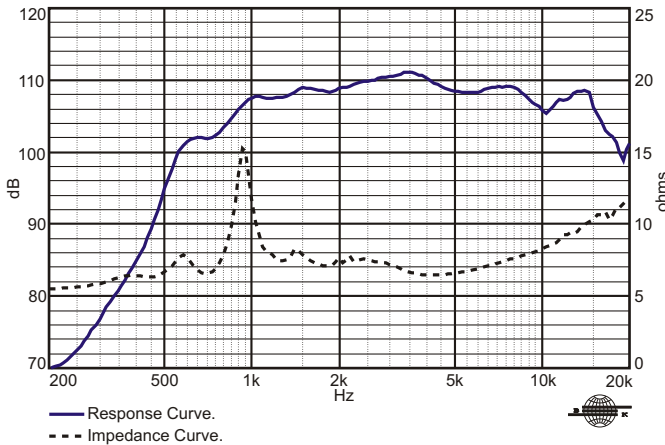

HARMONIC DISTORTION CURVES W/ HL14-50 HORN, 7.5 W / 1 m.

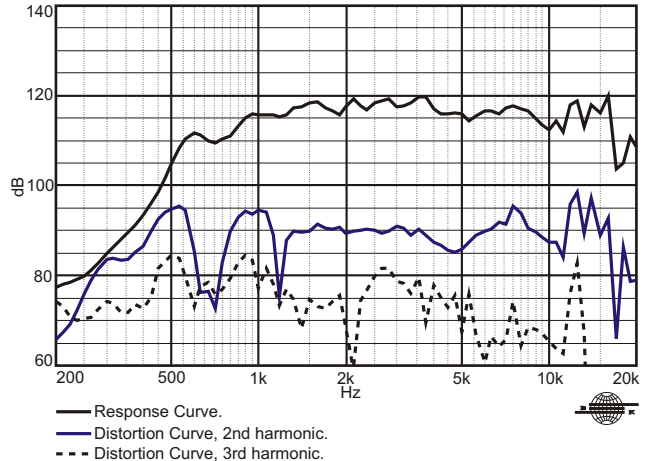

RESPONSE AND IMPEDANCE CURVES W/ PLANE-WAVE TUBE, 1 mW

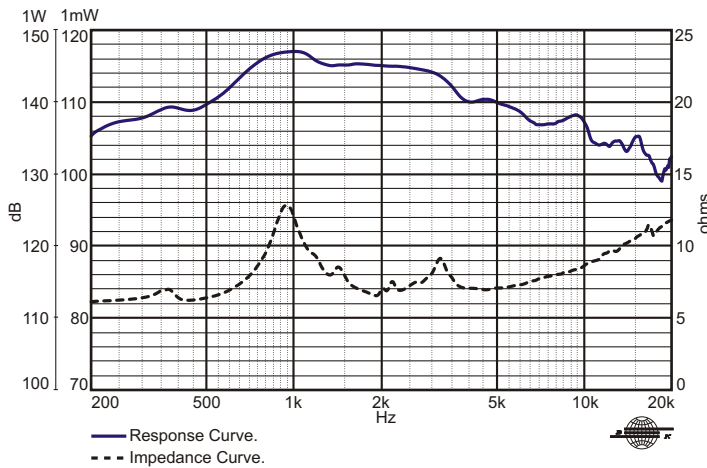

Frequency response and impedance curves measured with 50 mm terminated plane-wave tube, with sensitivity referenced to a 25 mm tube.

POLAR RESPONSE CURVES

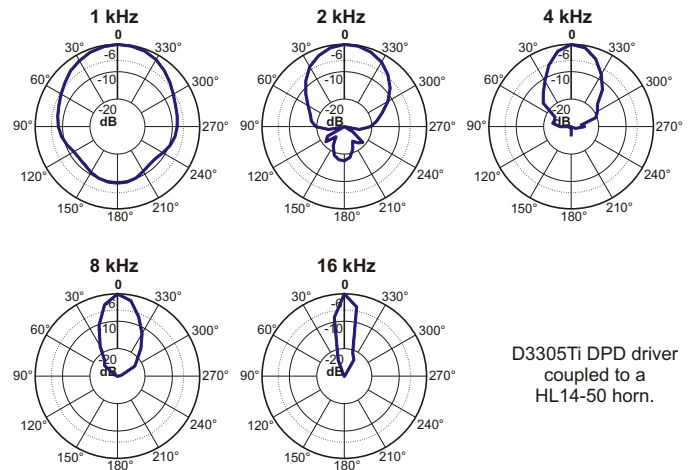

D3305Ti DPD driver coupled to a HL14-50 horn.

Polar Response Curve.

HARMONIC DISTORTION CURVES W/ HL14-50 HORN, 1 W / 1 m.

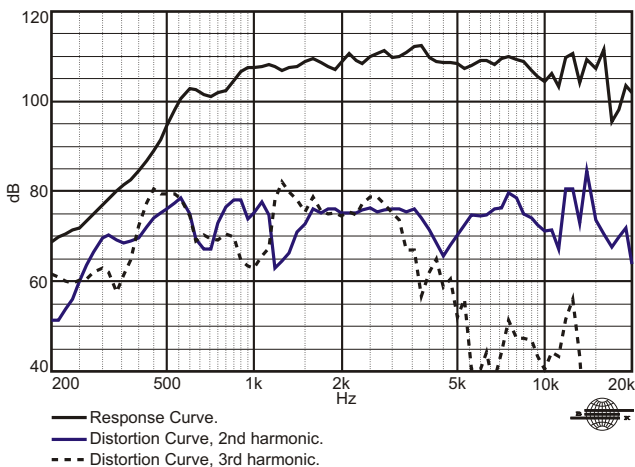

HOW TO CHOOSE THE RIGHT AMPLIFIER

The power amplifier must be able to supply twice the RMS driver power. This 3 dB headroom is necessary to handle the peaks that are common to musical programs. When the amplifier clips those peaks, high distortion arises and this may damage the transducer due to excessive heat. The use of compressors is a good practice to reduce music dynamics to safe levels.

FINDING VOICE COIL TEMPERATURE

It is very important to avoid maximum voice coil temperature. Since moving coil resistance (R_e) varies with temperature according to a well known law, we can calculate the temperature inside the voice coil by measuring the voice coil DC resistance:

$$T_B = T_A + \left(\frac{R_B}{R_A} - 1 \right) \left(T_A - 25 + \frac{1}{\alpha_{25}} \right)$$

T_A, T_B = voice coil temperatures in °C.

R_A, R_B = voice coil resistances at temperatures T_A and T_B , respectively.

α_{25} = voice coil wire temperature coefficient at 25 °C.

Kapton®: Du Pont trademark.

DPD® (Driver Protection Device): Selenium trademark.

IPF® (Impregnated Polymer Fiber): Selenium trademark.

Specifications subject to change without prior notice.

www.seleniumloudspeakers.com

Code: N/A Rev.: 00 - 05 /03